



FICHE D'HOMOLOGATION CONFORME A L'ANNEXE J DU CODE SPORTIF INTERNATIONAL
HOMOLOGATION FORM IN ACCORDANCE WITH APPENDIX J OF THE INTERNATIONAL SPORTING CODE

01 AVR. 1995

Homologation valable à partir du
Homologation valid as from

A) Voiture vue de 3/4 avant
Car seen from 3/4 front

B) Voiture vue de 3/4 arrière
Car seen from 3/4 rear



1. GENERALITES / GENERAL

101. Constructeur
Manufacturer AUDI AG

102. Dénomination(s) commerciale(s) - Modèle et type
Commercial name(s) - Model and type Audi A4

104. Mode de construction : a) Mode :
Type of car construction : Type :

répétés	monocoque
separés	unitary construction

b) Matériau du châssis / coque
Material of chassis / bodyshell Stahlblech, Kunststoff / steelplate, plastics

105. Nombre de volumes
Number of volumes 3

106. Nombre de places
Number of places 5

FEDERATION INTERNATIONALE
DE L' AUTOMOBILE
8, Place de la Concorde, 8
75008 PARIS

© FISA - FC - 1994 - 048.01.FB11.94

A9) Coque vue de 3/4 avant, sans portes, capots, etc.
Bodyshell seen from 3/4 front without doors, lids, etc.

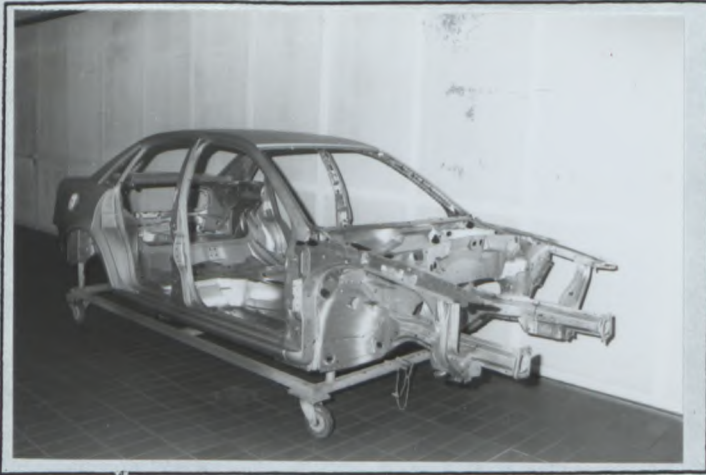

A10) Coque vue de 3/4 arrière, sans portes, capots, etc.
Bodywork seen from 3/4 rear without doors, lids, etc.



2. DIMENSIONS, POIDS / DIMENSIONS, WEIGHT

202. Longueur hors-tout / Overall length 4 479 mm +/- 1 %

203. Largeur hors-tout / Overall width 1 753 mm +/- 1 %

Endroit de mesure / Where measured Vordertür, Nähe B-Säule / front door, near B-pillar

204. Largeur de carrosserie / Width of bodywork

	a) A la hauteur de l'axe avant / At front axle	<u>1 746</u>	mm +/- 1 %
	b) A la hauteur de l'axe arrière / At rear axle	<u>1 725</u>	mm +/- 1 %

206. Empattement / Wheelbase 2 617 mm +/- 1 %

209. Porte-à-faux / Overhang

	a) Avant / Front	<u>897</u>	mm +/- 1 %		b) Arrière / Rear	<u>965</u>	mm +/- 1 %
--	------------------	------------	------------	--	-------------------	------------	------------

210. Distance "G" (volant - paroi de séparation arrière) / Distance "G" (steering wheel - rear bulkhead) 1 604 mm

© FISA - FC - 1994 - 048.01.FB.11.94

Marque Audi
 Make _____

Modèle Audi A4
 Model _____

ST - - 017

4. CIRCUIT DE CARBURANT / FUEL CIRCUIT

401. Réservoir : b) Emplacement unter Fahrzeugboden: unter Kofferraum und über Hinterachse /
 Fuel tank : Location under the floor: under luggage compartment and above rear axle

6. TRANSMISSION / POWER TRAIN

601. Roues motrices : avant

oui	non
yes	no

 arrière

oui	non
yes	no

 Driven wheels : front rear

603. Boîte de vitesses : a1) Emplacement dans l'empattement

moitié avant	moitié arrière
front half	rear half

 Gearbox : Location in wheelbase

XII) CHAÎNE CINÉMATIQUE (4 roues motrices) / KINEMATIC TRAIN (4 wheel drive) :

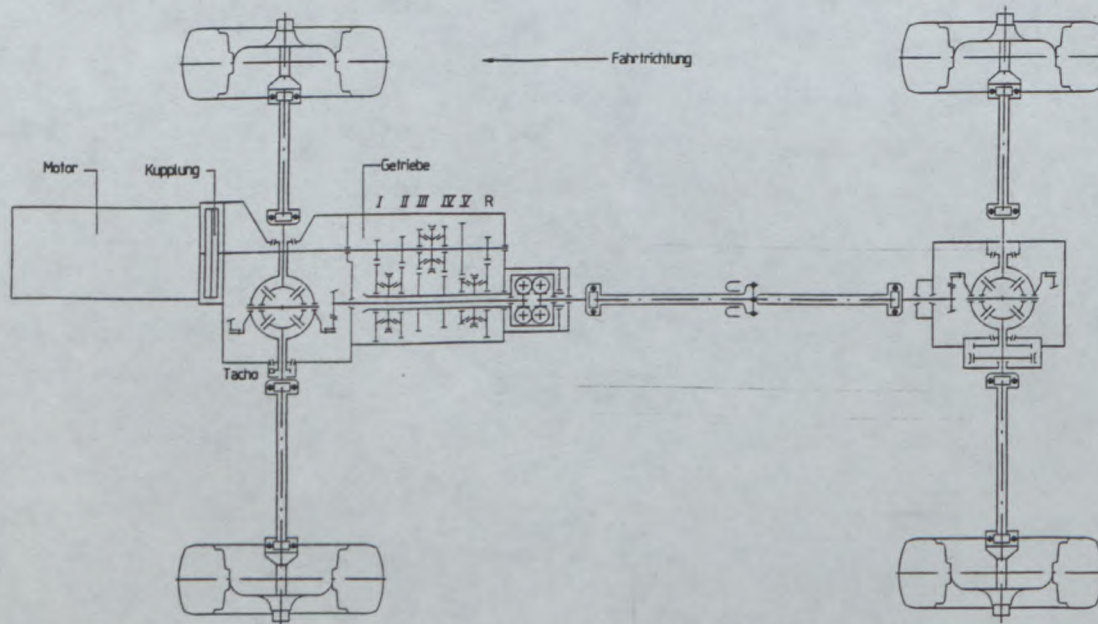

**FEDERATION INTERNATIONALE
 DE L'AUTOMOBILE
 8, Place de la Concorde, 8
 75008 PARIS**

Modifications nécessaires pour passer d'une version 2 roues motrices (au moins 2500 exemplaires) à une version 4 roues motrices (au moins 2500 exemplaires) / Modifications necessary in order to go from a 2-wheel drive version (at least 2500 cars) to a 4-wheel drive version (at least 2500 cars)

- Art. 206: wheelbase: 2607 mm \pm 1 %
- Art. 209 b): overhang rear: 975 mm \pm 1 %
- Art. 401 b): fuel tank location: under the floor:
under luggage compartment, in front and above rear axle
- Art. 601: driven wheels: front: yes rear: yes
- Art. 701 a): type of suspension rear: twin wishbone suspension
- Photo U:



- Art. 9 bodywork: - different rear body platform and side member because of different mountings of rear suspension, cross member and differential
- additional bearing support for propshaft

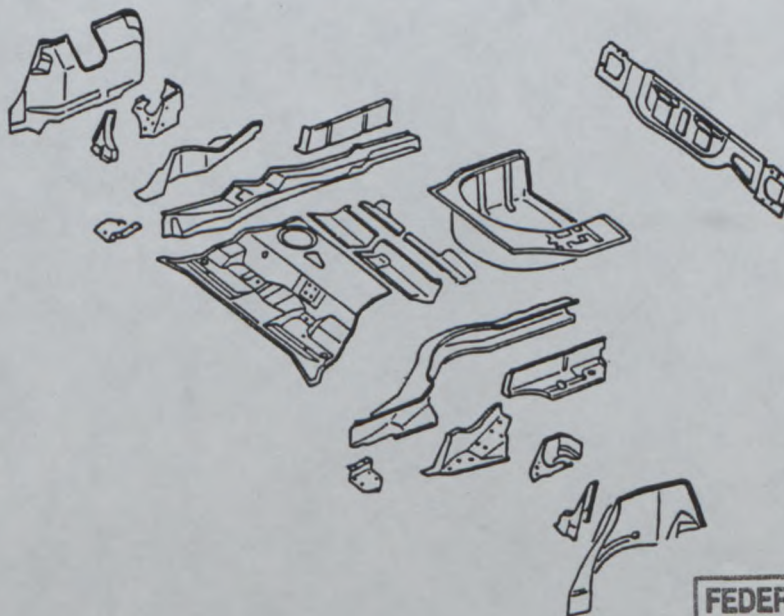

7. SUSPENSION / SUSPENSION

	Avant / Front	Arrière / Rear
701. Généralités General		
a) Type de suspension Type of suspension	Vierlenkerachse / four link front suspension	Verbundlenkerachse / torsion beam axle
702. Ressorts hélicoïdaux Helicoïdal springs	oui non yes no	oui non yes no
703. Ressorts à lames Leaf springs	oui non yes no	oui non yes no
704. Barres de torsion Torsion bars	oui non yes no	oui non yes no

705. Autre type de suspension : *Voir description sur fiche additionnelle*
 Other type of suspension : *See description on additional form*

	Avant / Front	Arrière / Rear
707. Amortisseurs : Shock absorbers :		
a) Nombre par roue Number per wheel	<u>1</u>	<u>1</u>

T) Train avant complet déposé
 Complete dismantled front axle

U) Train arrière complet déposé
 Complete dismantled rear axle

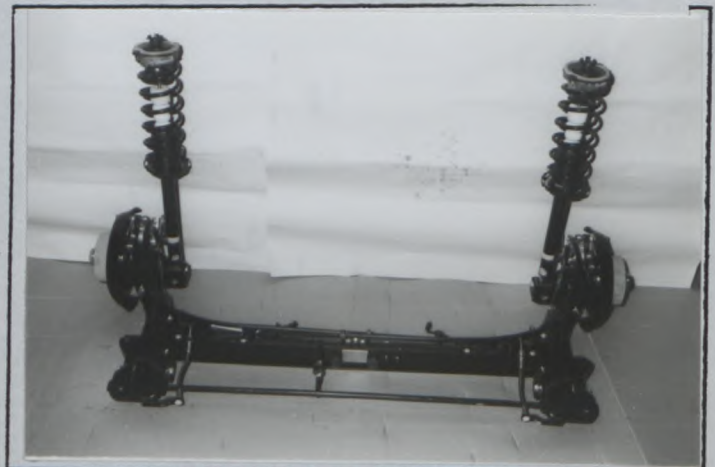
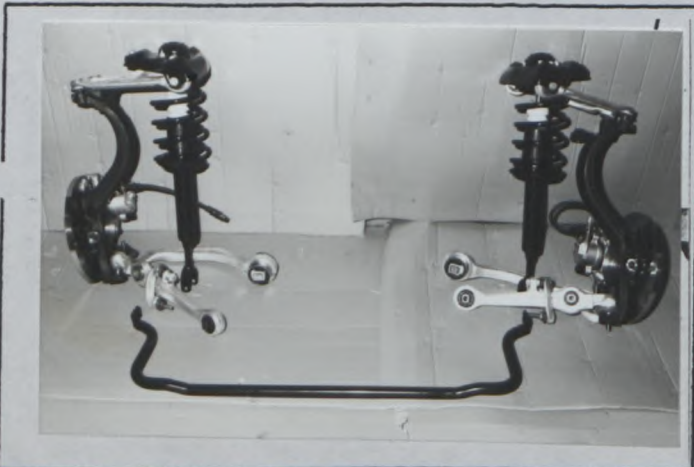

8. TRAIN ROULANT / RUNNING GEAR

	Avant / Front	Arrière / Rear
804. Direction : Steering :		
a) Type Type	Zahnstangenlenkung / rack and pinion steering	./.

9. CARROSSERIE / BODYWORK

X) Tableau de bord
Dashboard



902. Extérieur :
Exterior :

a) Nombre de portes
Number of doors 4

b) Hayon
Tailgate

oui	non
yes	no

Avant / Front	Arrière / Rear
<u>Stahl, Alu / steel, alu</u>	<u>Stahl, Alu / steel, alu</u>

c) Matériau des portières
Door material

d) Matériau du capot avant
Front bonnet material Stahlblech/steelplate

e) Matériau du capot arrière / hayon
Rear bonnet / tailgate material Stahlblech/steelplate

f) Matériau de la carrosserie
Bodywork material Stahlblech, Kunststoff: EMPP / steelplate, plastics: EMPP

h) Matériau de lunette arrière
Rear window material Sicherheitsglas /
safety glass

i) Matériau des glaces de custode
Rear quarter window material Sicherheitsglas /
safety glass

Avant / Front	Arrière / Rear
<u>Sicherheitsglas / safety glass</u>	<u>Sicherheitsglas / safety glass</u>
<u>Aluminium, Kunststoff: EMPP aluminium, plastics: EMPP</u>	<u>Aluminium, Kunststoff: EMPP aluminium, plastics: EMPP</u>

k) Matériau des vitres latérales
Side window material

l) Matériau du pare-choc
Material of bumper

Marque
Make

Audi

Modèle
Model

Audi A4

ST - - 017

XIII) PARTIES DE CARROSSERIE SYNTHETIQUES / SYNTHETIC PARTS OF THE BODY :

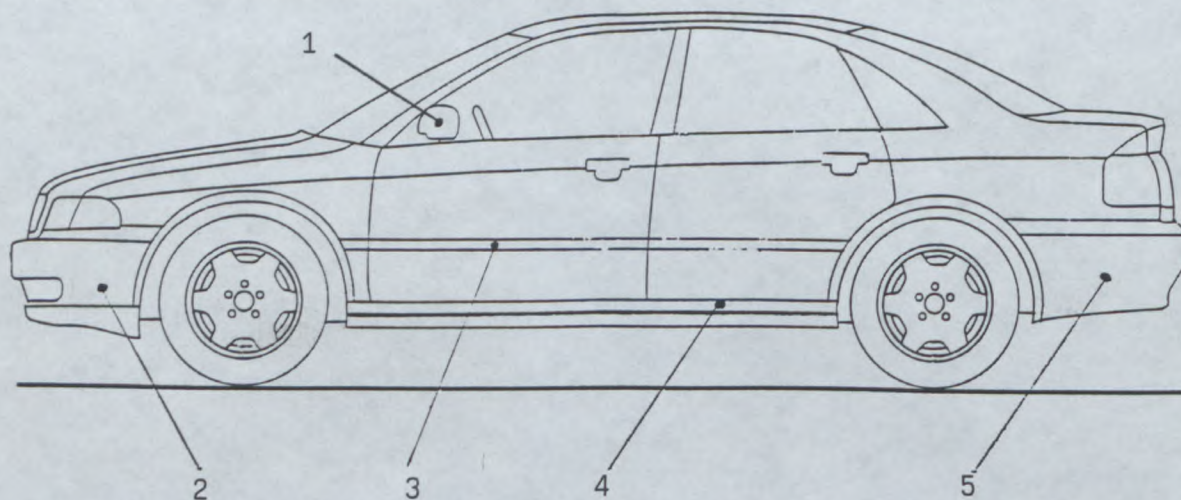

- | | |
|----------------------------------|--------------------------------------|
| 1 Außenspiegel / mirrors | 4 Schwellerabdeckung / cover of sill |
| 2 Stoßfänger vorn / front bumper | 5 Stoßfänger hinten / rear bumper |
| 3 Zierleisten / moldings | |

INFORMATIONS COMPLEMENTAIRES / COMPLEMENTARY INFORMATION :

FEDERATION INTERNATIONALE
DE L'AUTOMOBILE
8, Place de la Concorde, 8
75008 PARIS



FEDERATION INTERNATIONALE DE L'AUTOMOBILE

Homologation No

ST - - 017

Extension No

Groupes
Group

~~A/B/N/T~~

Supertourisme
Supertouring

CERTIFICAT DE DIMENSIONS INTERIEURES
CERTIFICATE FOR INTERIOR DIMENSIONS

Véhicule: Constructeur
Vehicle: Manufactureur

AUDI AG

Modèle et type
Model and type

Audi A4

Dimensions intérieures comme définies par le Règlement d'Homologation
Interior dimensions as defined by the Homologation Regulations

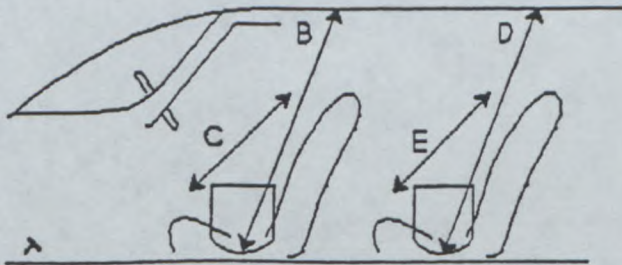

	(Hauteur sur sièges avant)	958	mm
B	(Height above front seats)		
	(Largeur aux sièges avant)	1 431	mm
C	(Width at front seats)		
	(Hauteur sur sièges arrière)	928	mm
D	(Height above rear seats)		
	(Largeur aux sièges arrière)	1 402	mm
E	(Width at rear seats)		

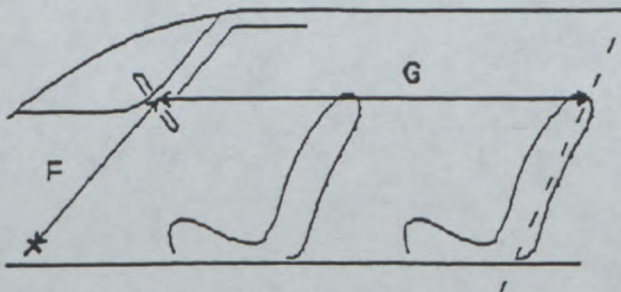

	(Volant - Pédale de frein))	675	mm
F	(Steering wheel - Brake pedal)		
	(Volant - paroi de séparation arrière)	1 604	mm
G	(Steering wheel - rear bulkhead)		
H	= F + G =	2 279	mm

FEDERATION INTERNATIONALE
DE L'AUTOMOBILE
8, Place de la Concorde, 8
75008 PARIS



FEDERATION INTERNATIONALE
DE L'AUTOMOBILE

Homologation No

ST - - 017

Gruppe
Group

~~A/B/N/T~~ / Supertourisme
Supertouring

Extension No

01/01VO

FICHE D'EXTENSION D'HOMOLOGATION POUR ARMATURE DE SECURITE
FORM OF HOMOLOGATION EXTENSION FOR SAFETY CAGE

VO Variante option / Option variant

Véhicule: Constructeur AUDI AG Modèle et type Audi A4
Vehicle: Manufactureur AUDI AG Model and type Audi A4

Homologation valable à partir du 01 AVR. 1995
Homologation valid as from 01 AVR. 1995

	Arceau principal Main rollbar	Entretoise longitudinale Longitudinal strut	Entretoise diagonale Diagonal Strut	Arceau avant Front rollbar
Matériau Material	<u>Stahl / steel</u>	<u>Stahl / steel</u>	<u>Stahl / steel</u>	<u>Stahl / steel</u>
Diamètre extérieur Exterior diameter	<u>40</u> mm	<u>40</u> mm	<u>40</u> mm	<u>40</u> mm
Epaisseur de paroi Wall thickness	<u>1,5</u> mm	<u>1,5</u> mm	<u>1,0</u> mm	<u>1,0</u> mm
Limite élastique Elastic limit	<u>600</u> daN/mm ²	<u>600</u> daN/mm ²	<u>600</u> daN/mm ²	<u>600</u> daN/mm ²
Résistance à la traction Tensile strength	<u>700 - 820</u> daN/mm ²	<u>700 - 820</u> daN/mm ²	<u>700 - 820</u> daN/mm ²	<u>700 - 820</u> daN/mm ²

Fabricant de l'armature Winfried Mastter GmbH Poids total y compris les fixations 43,5 kg
Structure manufacturer Winfried Mastter GmbH Total weight including fixations 43,5 kg

Armature complète hors de la voiture
Complete structure outside the car

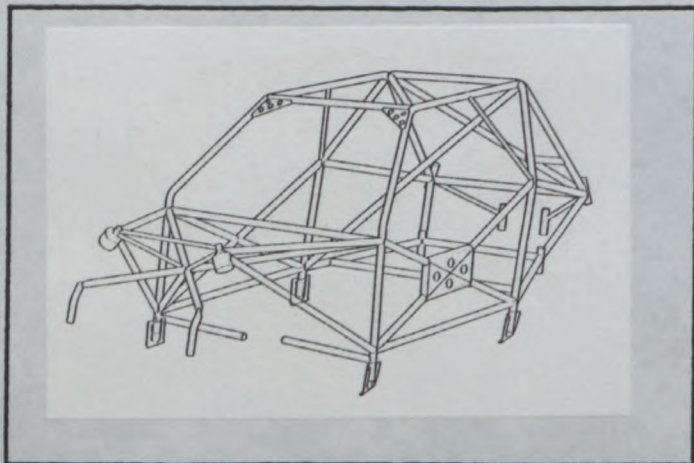

Nous attestons que la présente armature de sécurité répond aux dispositions de l'Annexe J de la FIA, en particulier en ce qui concerne ses implantations, ses connexions, et ses résistances aux contraintes.

We certify that the present safety structure complies with the conditions of the FIA Appendix J, in particular with regard to its attachments, its connections, and its stress resistances.

Signature du représentant du constructeur du véhicule
Signature of the car manufacturer representative

AUDI AG

i. V.

H.-J. Däwel

FEDERATION INTERNATIONALE
DE L'AUTOMOBILE
8, Place de la Concorde, 8
75008 PARIS

PHOTO No 1

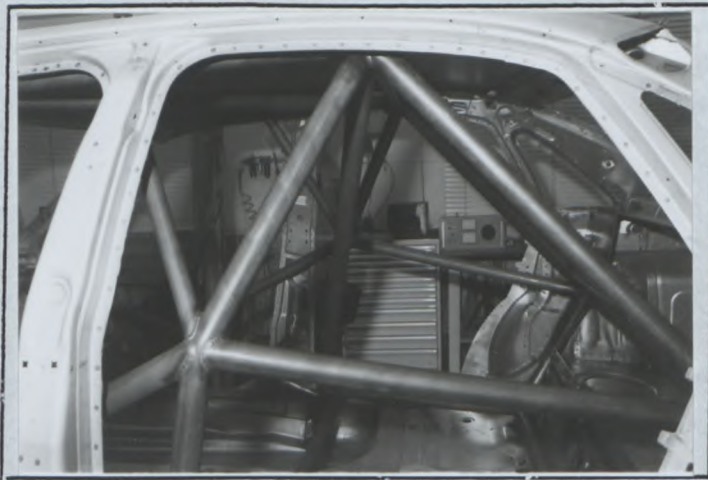

PHOTO No 2

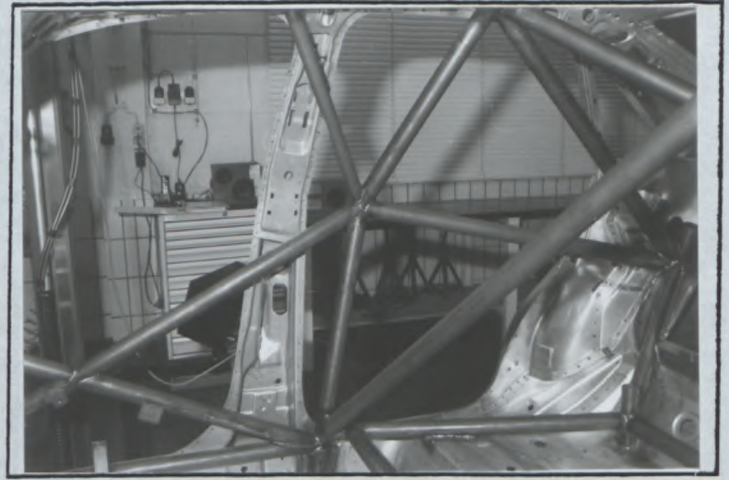

PHOTO No 3

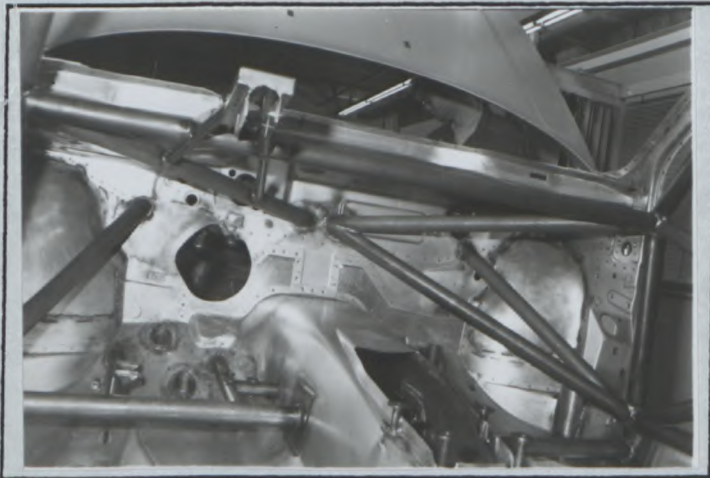

PHOTO No 4

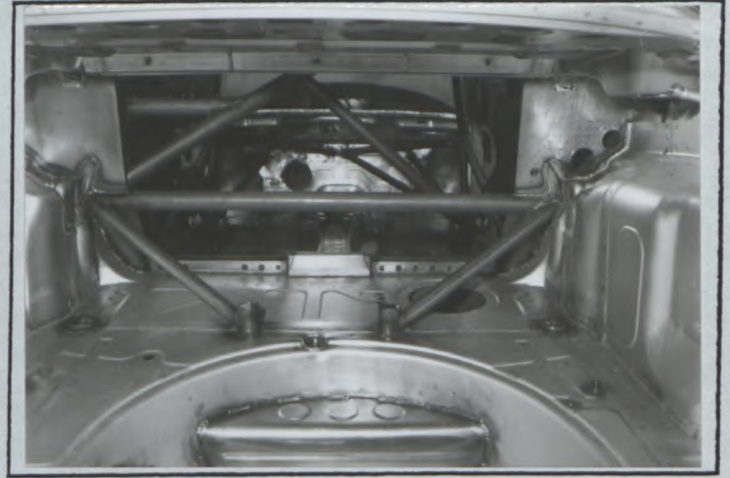

PHOTO No 5

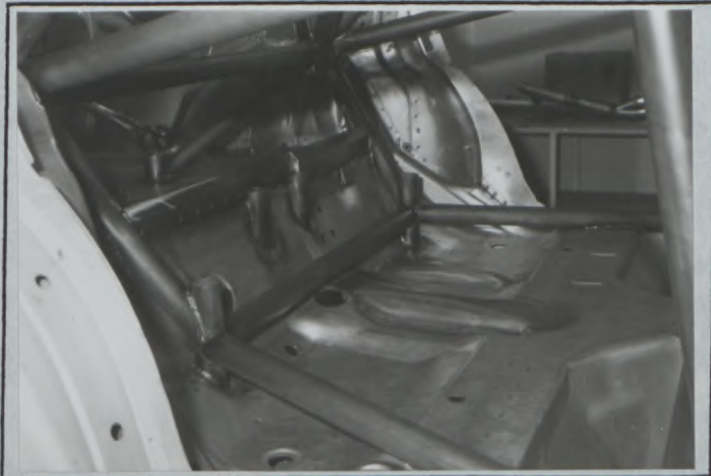

PHOTO No 6



Marque
Make

Audi

Modèle
Model

Audi A4

Homologation No

ST - - 017

Extension No

017 01 V0

PHOTO No 7

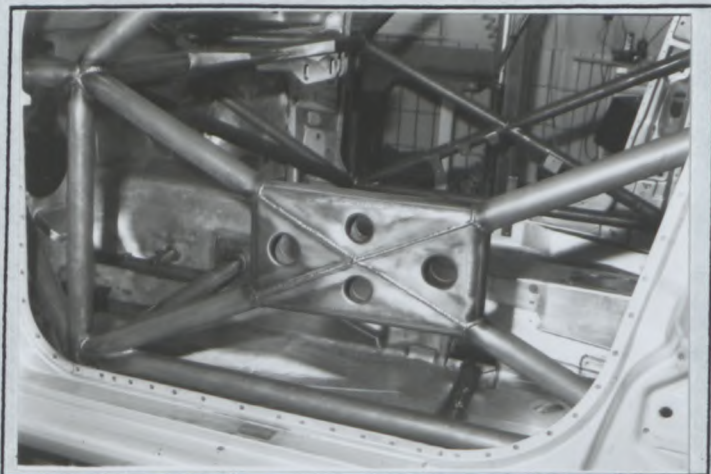

PHOTO No 8

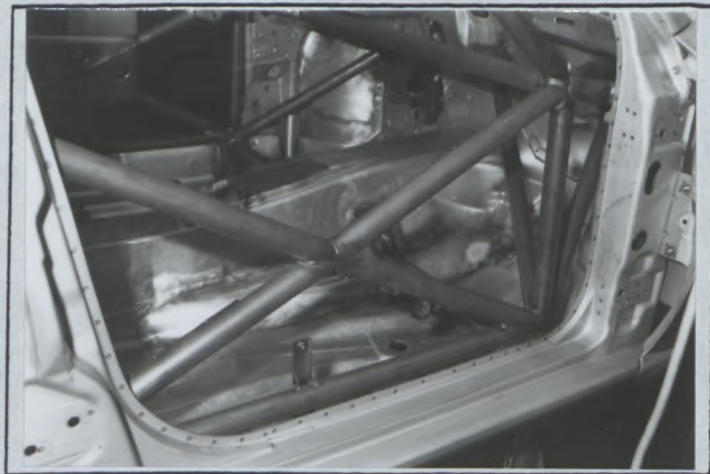

PHOTO No 9

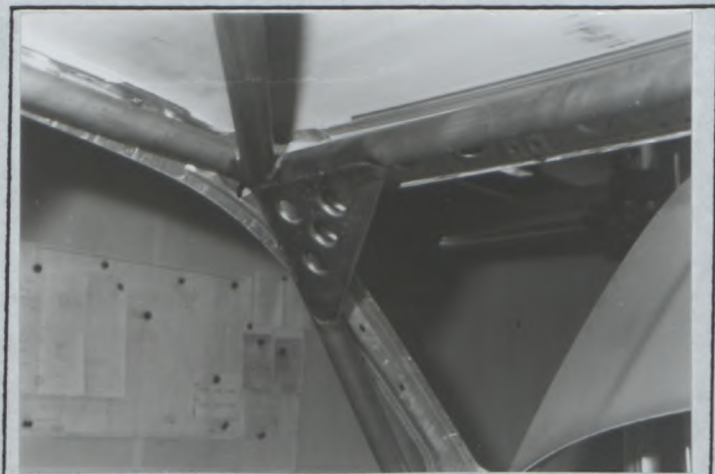

PHOTO No 10

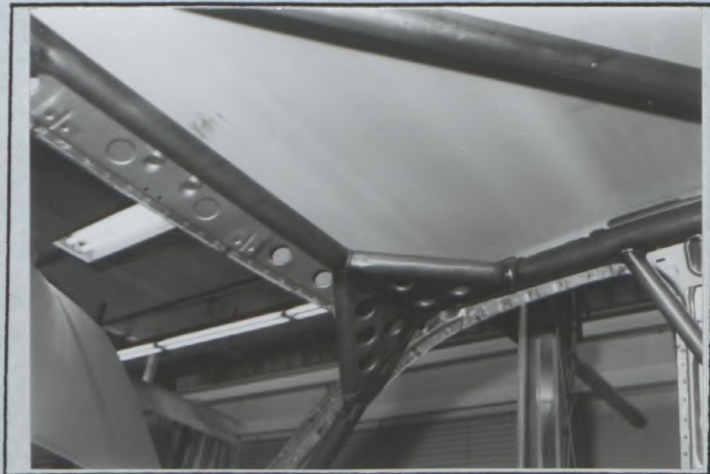
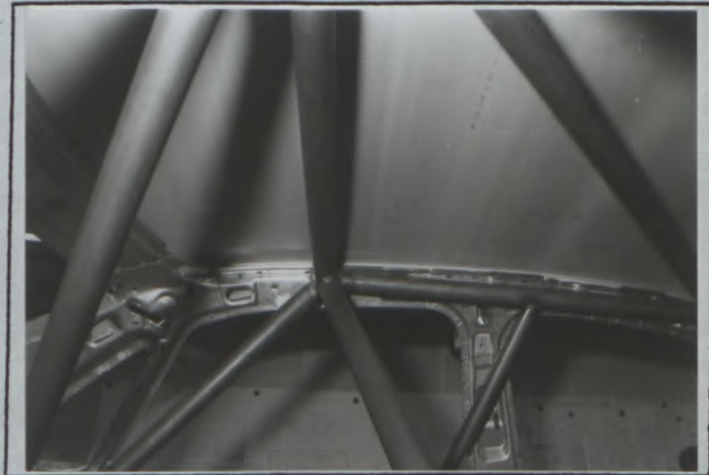

PHOTO No 11



PHOTO No 12



FEDERATION INTERNATIONALE
DE L'AUTOMOBILE
8, Place de la Concorde, 8
75008 PARIS

Marque
Make

Audi

Modèle
Model

Audi A4

numérogation No

ST - - 017

Extension No

01/01V0

PHOTO No 13

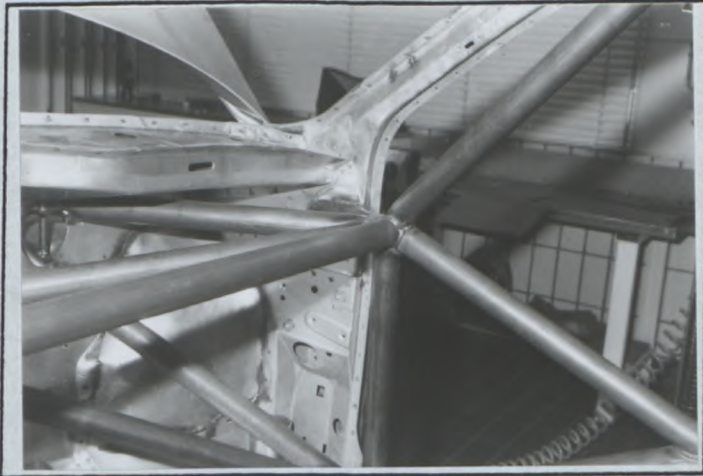

PHOTO No 14

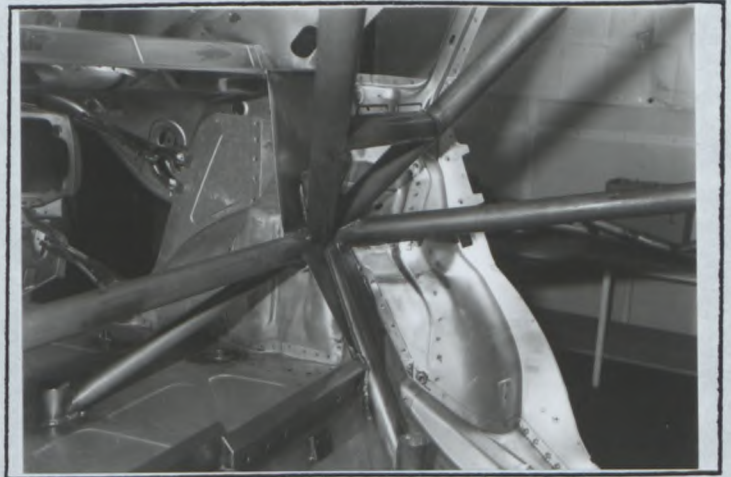

PHOTO No 15

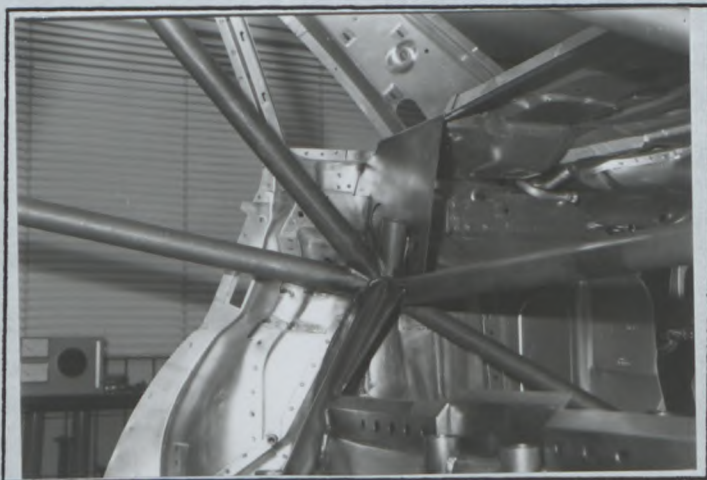

PHOTO No 16

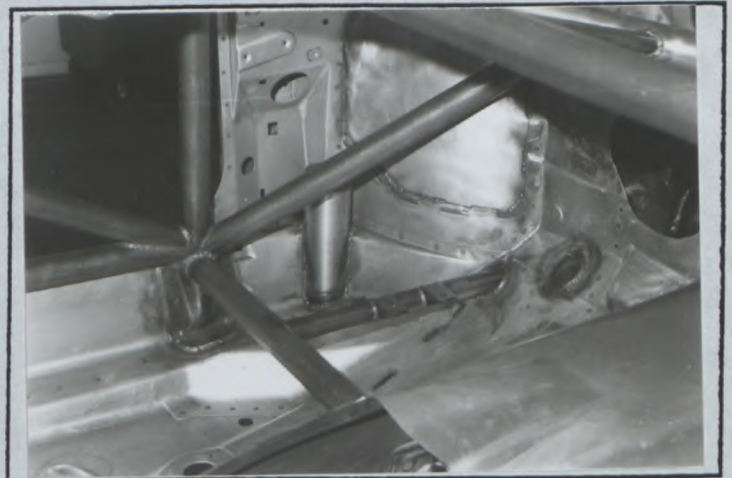

PHOTO No 17

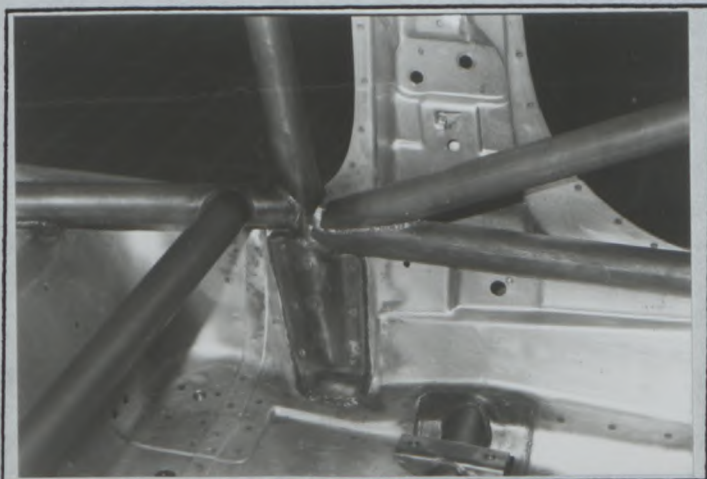
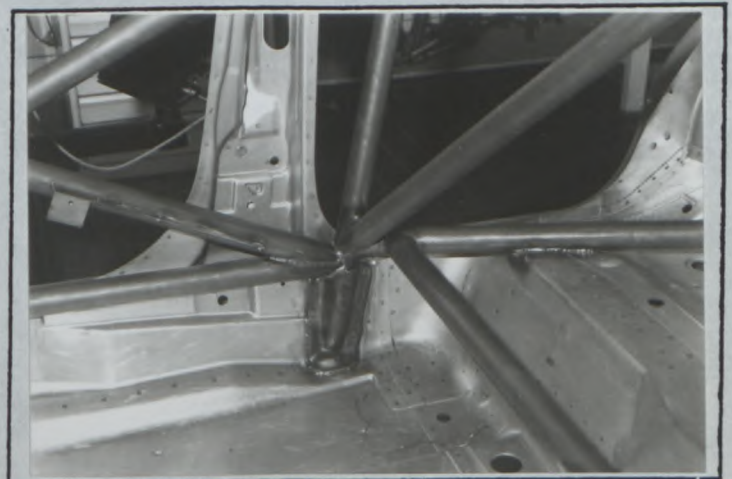

PHOTO No 18



Marque
Make

Audi

Modèle
Model

Audi A4

numérotation No
ST - - 017

Extension No
01/01V0

PHOTO No 19

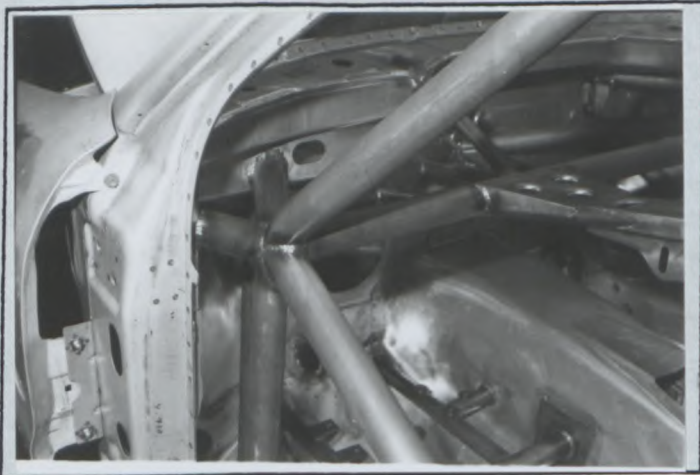

PHOTO No 20

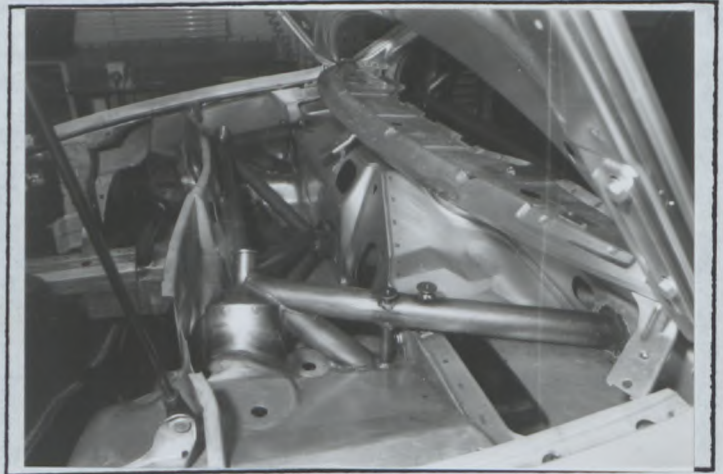

PHOTO No

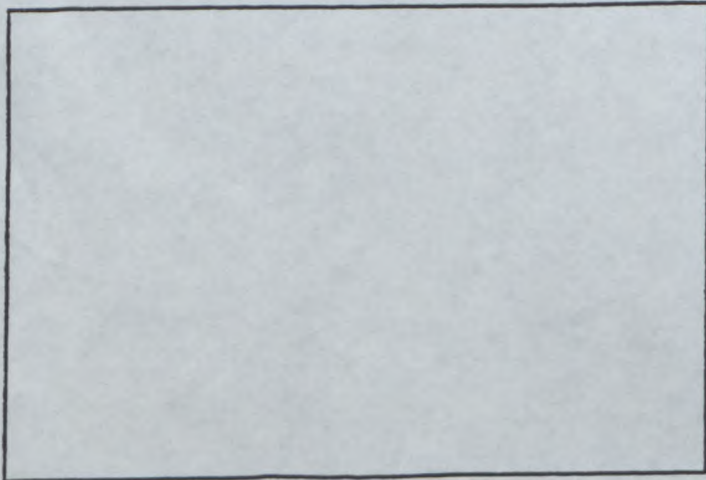

PHOTO No

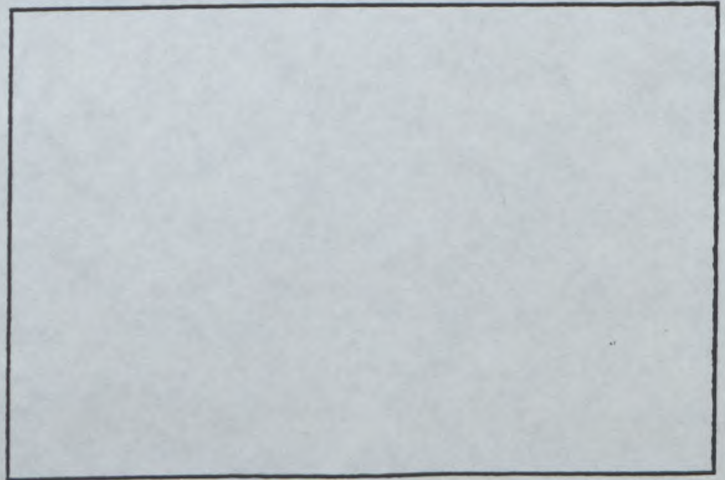

PHOTO No

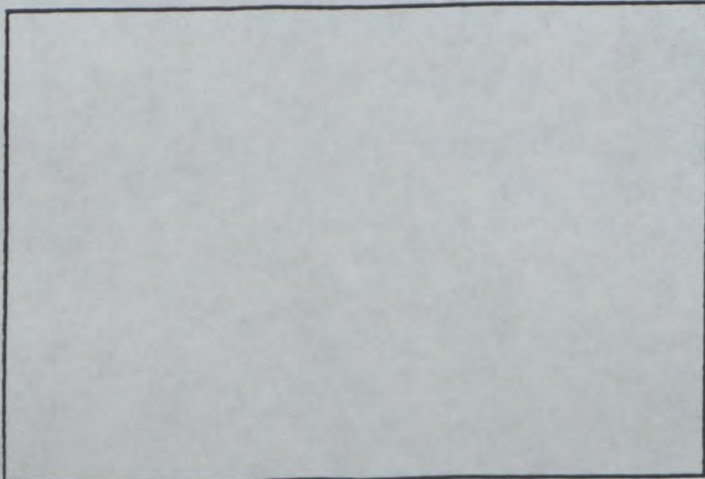
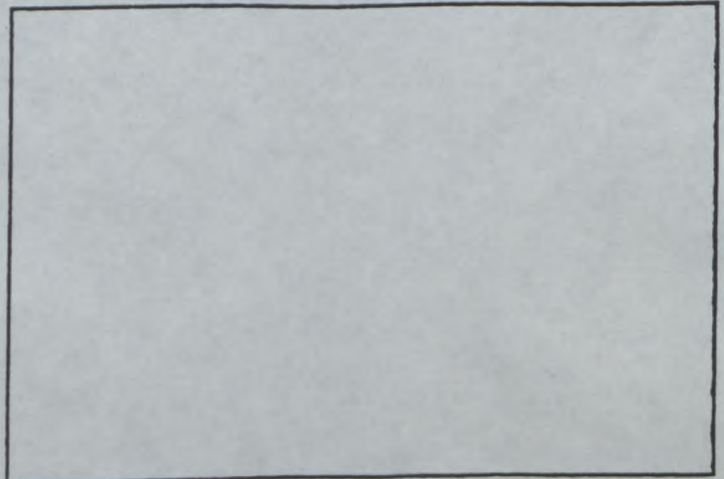

PHOTO No





SI - - 017

VO

Extension N°

02/02 VO

vehicle: manufactureur AUDI AG model and type Audi A4

FICHE D'EXTENSION D'HOMOLOGATION POUR DISPOSITIFS AERODYNAMIQUES EN SUPERTOURISME HOMOLOGATION EXTENSION FORM FOR AERODYNAMIC DEVICES IN SUPER TOURING

Homologation valable à partir du Homologation valid as from 01 AVR. 1995

A) Voiture vue de 3/4 avant Car seen from 3/4 front



B) Voiture vue de 3/4 arrière Car seen from 3/4 rear

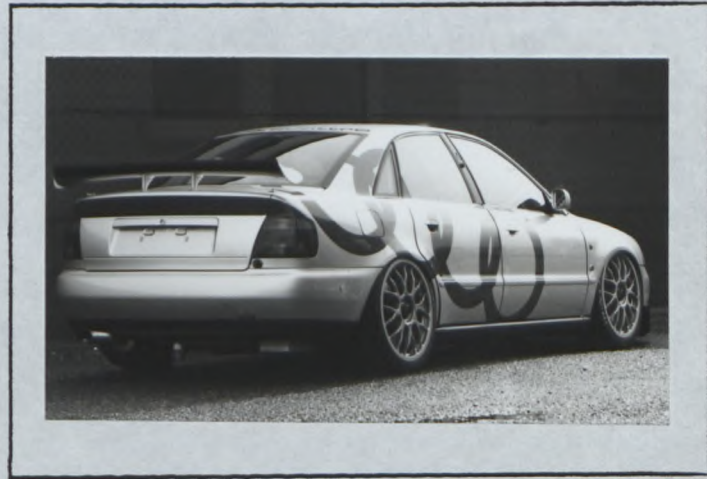

9. CARROSSERIE / BODYWORK

XVI) DISPOSITIF AVANT DEPOSE ET VU DE FACE AVEC DIMENSIONS DES OUVERTURES : DISMOUNTED FRONT DEVICE SEEN FROM FRONT WITH DIMENSIONS OF OPENINGS:



360 x 60

695 x 60

695 x 100

360 x 60

(tolerances ± 1%)

FEDERATION INTERNATIONALE DE L'AUTOMOBILE 8, Place de la Concorde, 8 75008 PARIS

Marque
Make

AUDI AG

Modèle
Model

Audi A4

Homologation N°

ST--017

Extension N°

02/02 V0

XVIII) DISPOSITIF AVANT DEPOSE ET VU DE COTE AVEC DIMENSIONS DES OUVERTURES :
DISMOUNTED FRONT DEVICE IN SIDE VIEW WITH DIMENSIONS OF OPENINGS:

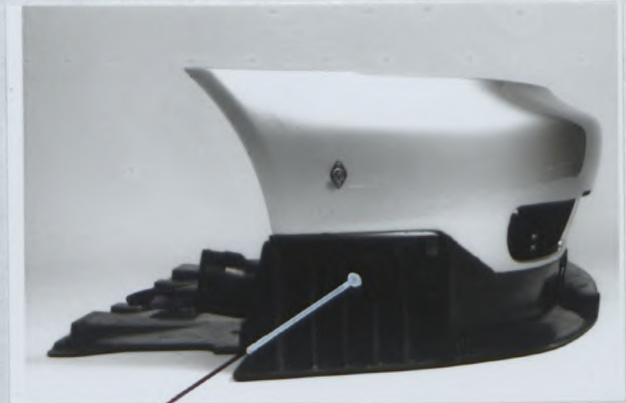

300 x 185 (tolerances $\pm 1\%$)

XXIII) DISPOSITIF AVANT EN PLACE ET VU DE FACE :
MOUNTED FRONT DEVICE SEEN FROM FRONT:



XXIV) DISPOSITIF AVANT EN PLACE ET VU DE COTE :
MOUNTED FRONT DEVICE IN SIDE VIEW:



FEDERATION INTERNATIONALE
DE L'AUTOMOBILE
8, Place de la Concorde, 8
75008 PARIS

Marque
Make

AUDI AG

Modèle
Model

Audi A4

Homologation N°

ST - 017

Extension N°

02/02 V0

XVII) DISPOSITIF ARRIERE EN PLACE
ET VU DE COTE :
MOUNTED REAR DEVICE IN SIDE VIEW:



XIX) SECTION DU DISPOSITIF ARRIERE AU
NIVEAU DE L'AXE LONGITUDINAL DE LA
VOITURE :
SECTION OF REAR DEVICE AT CAR'S
CENTERLINE LEVEL:

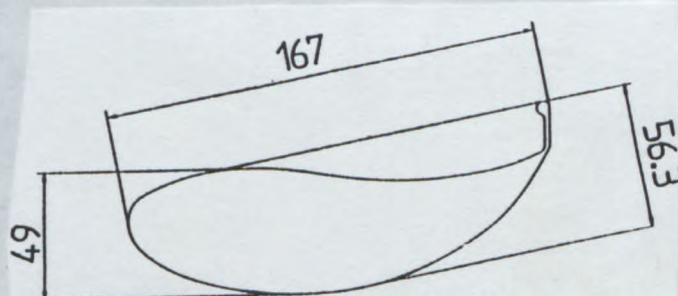

XX) DISPOSITIF ARRIERE EN PLACE ET VU DE DESSUS :
MOUNTED REAR DEVICE SEEN FROM ABOVE:



XXI) DISPOSITIF ARRIERE DEPOSE ET
VU DE COTE :
DISMOUNTED REAR DEVICE IN SIDE VIEW:



FEDERATION INTERNATIONALE
DE L'AUTOMOBILE
8, Place de la Concorde, 8
75008 PARIS

Marque Make AUDI AG Modèle Model Audi A4

Homologation N°
01-017

Extension N°
02/02V0

XXII) DISPOSITIF ARRIERE DEPOSE ET VU DE DESSUS :
DISMOUNTED REAR DEVICE SEEN FROM ABOVE:

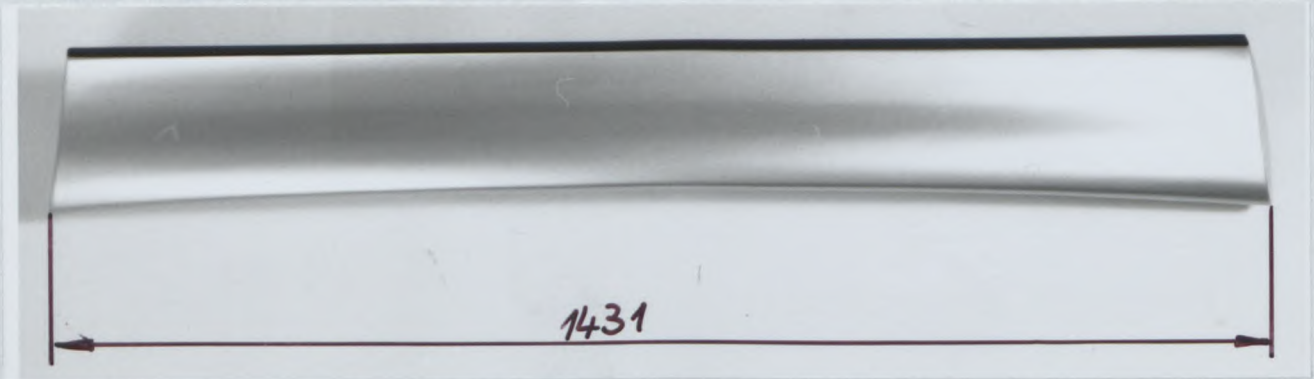

tolerances $\pm 1\%$

902. Extérieur : p) Angle entre dispositif arrière et carrosserie $15,5^\circ \pm 1^\circ$
Exterior: Angle between rear device and bodywork



INFORMATIONS COMPLEMENTAIRES / COMPLEMENTARY INFORMATION :

see photo XVIII

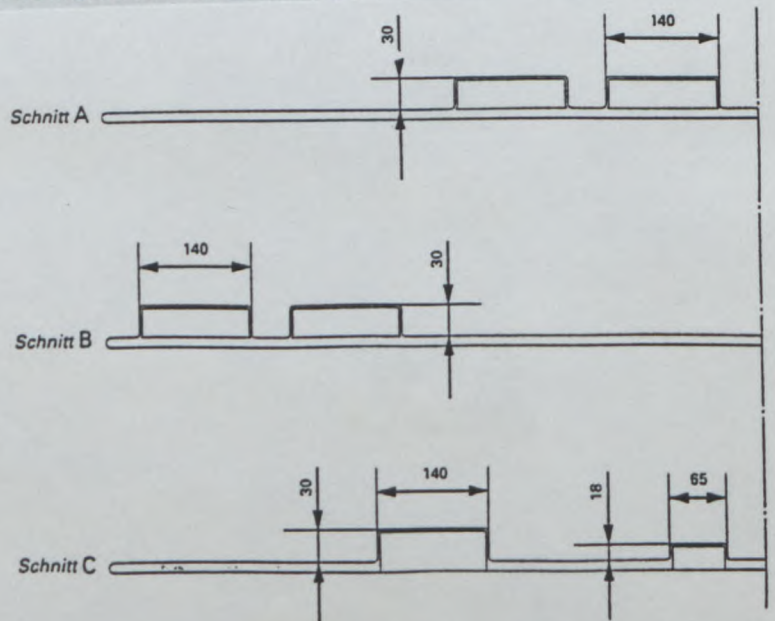
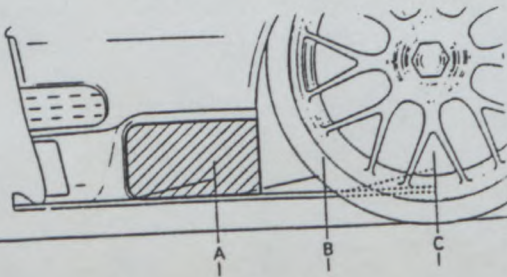

- inside the engine compartment mounted airducts on the plate for air exhaust tolerances $\pm 1\%$



FEDERATION INTERNATIONALE DE L'AUTOMOBILE

Homologation No

ST - - 017

Groupe Group

~~A/B/N/T~~

Supertourisme Supertouring

Extension No

03/03VO

FICHE D'EXTENSION D'HOMOLOGATION FORM OF HOMOLOGATION EXTENSION

- ES Evolution sportive du type / Sporting evolution of the
ET Evolution normale du type / Normal evolution of the
VF Variante de fourniture / Supply variant
X VO Variante option / Option variant
ER Erratum / Erratum

Vehicule: Constructeur AUDI AG
Vehicle: Manufactureur
Modèle et type Audi A4
Model and type

Homologation valable à partir du 01 AVR. 1995
Homologation valid as from

Table with 3 columns: Page ou ext., Article, Description. Row 1: 6, 902, verstaerkte Befestigungspunkte und Aufnahme des Fahrersitzes / reinforced mounting points and supports of drivers seat. Includes a technical drawing of seat mounting points and a signature.

FEDERATION INTERNATIONALE DE L'AUTOMOBILE 8, Place de la Concorde, 8 75008 PARIS

Marque
Make

Audi

Modèle
Model

Audi A4

Homologation No

ST - - 017

Extension No

03/03 V0

PHOTO No 1

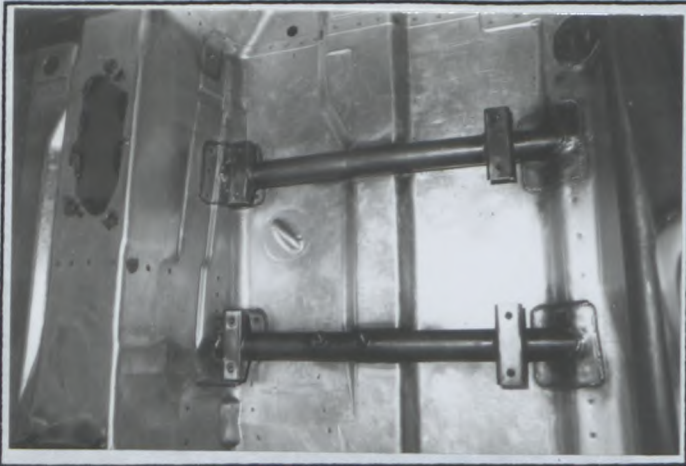

PHOTO No 2

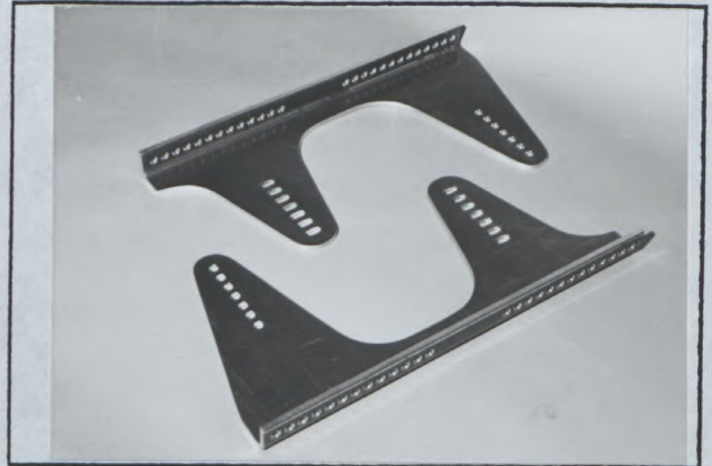

PHOTO No

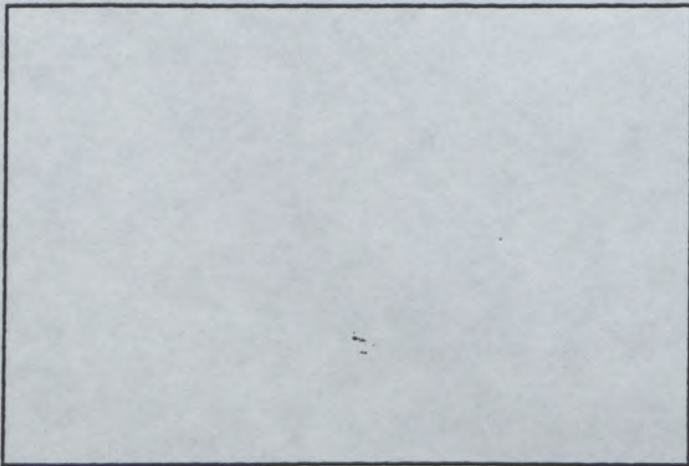

PHOTO No

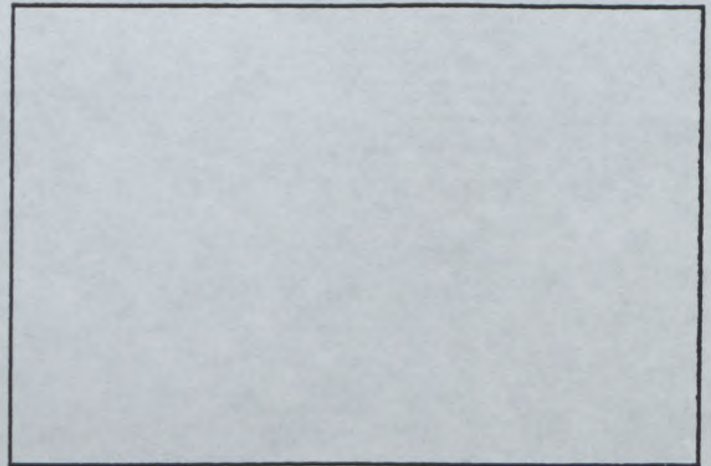

PHOTO No

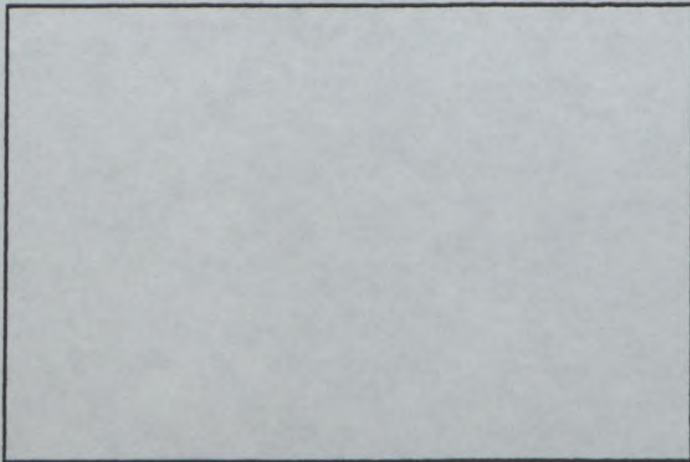
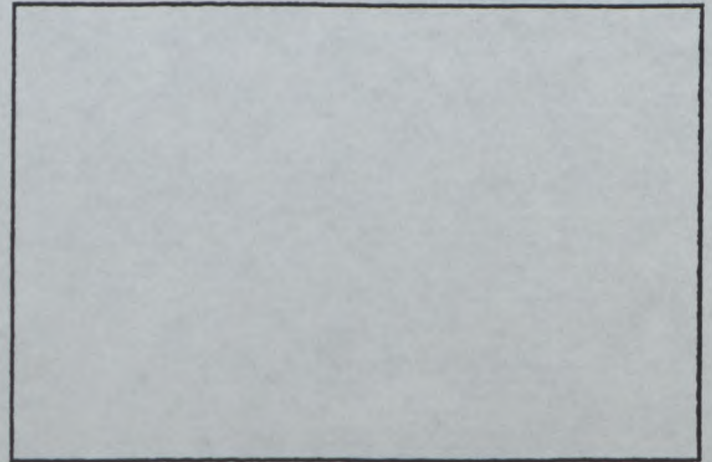

PHOTO No



FEDERATION INTERNATIONALE
DE L'AUTOMOBILE
8, Place de la Concorde, 8
75008 PARIS



FEDERATION INTERNATIONALE DE L'AUTOMOBILE

Homologation No

ST-017

Groupe Group

~~A/B/N/T1~~ / Supertourisme Supertouring

Extension No

04 / 01 ER

FICHE D'EXTENSION D'HOMOLOGATION FORM OF HOMOLOGATION EXTENSION

- ES Evolution sportive du type / Sporting evolution of the
- ET Evolution normale du type / Normal evolution of the
- VF Variante de fourniture / Supply variant
- VO Variante option / Option variant
- ER Erratum / Erratum

Véhicule: Constructeur / Vehicle: Manufactureur AUDI AG Modèle et type / Model and type Audi A4

01 AVR. 1995

Homologation valable à partir du / Homologation valid as from _____

Page ou ext. Page or ext.	Article Article	Description Description
01/01	VO	<p>neues Photo / new Photo 11 / 12</p> <p>zusätzliche Photos / additional photos 21 / 22 / 23 / 24 / 25 / 26</p>

© FIA - FC - 1990 - 010.04.FB.11.94

FEDERATION INTERNATIONALE DE L'AUTOMOBILE

8, place de la Concorde, 75008 Paris
Services Administratifs :
8 bis rue Boissy d'Anglas, 75008 Paris

Marque
Make

Audi

Modèle
Model

Audi A4

Homologation No

ST-017

Extension No

04/01ER

PHOTO No 11



PHOTO No 12



PHOTO No 21



PHOTO No 22



PHOTO No 23



PHOTO No 24

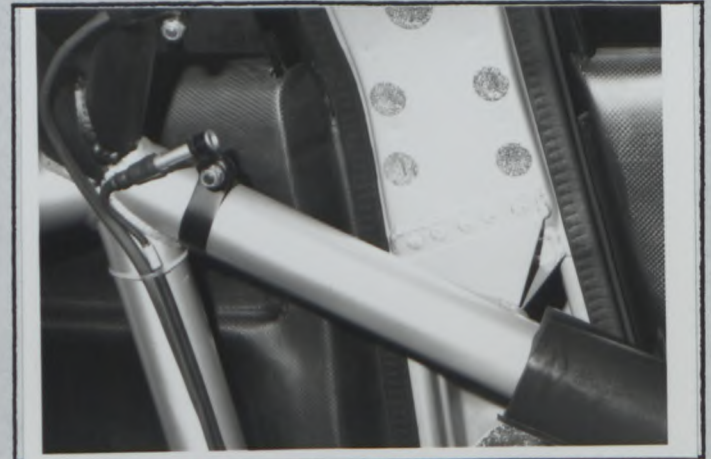

Marque
Make

Audi

Modèle
Model

Audi A4

Homologation No

ST-017

Extension No

04 / 01 ER

PHOTO No 25

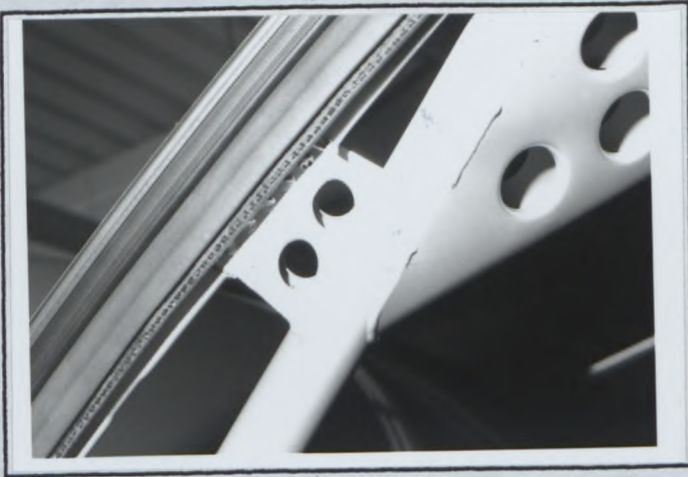

PHOTO No 26

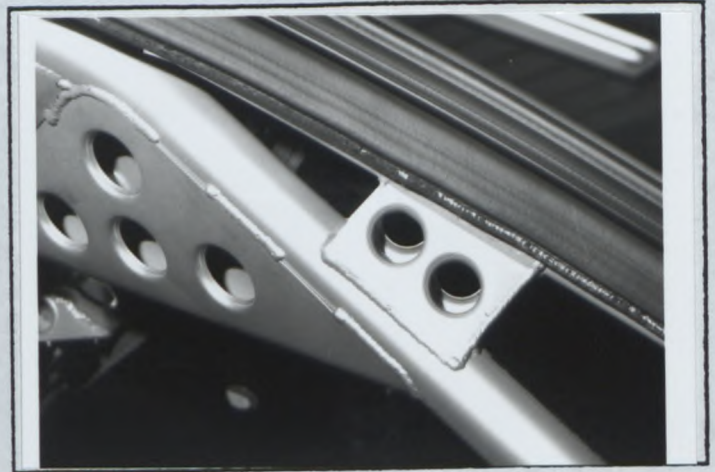

PHOTO No

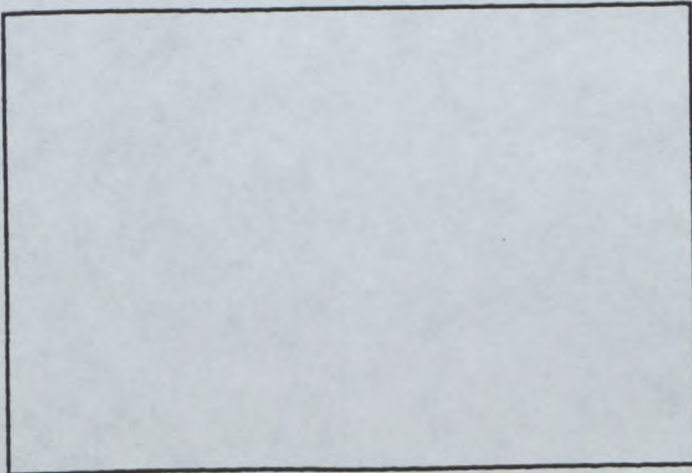

PHOTO No

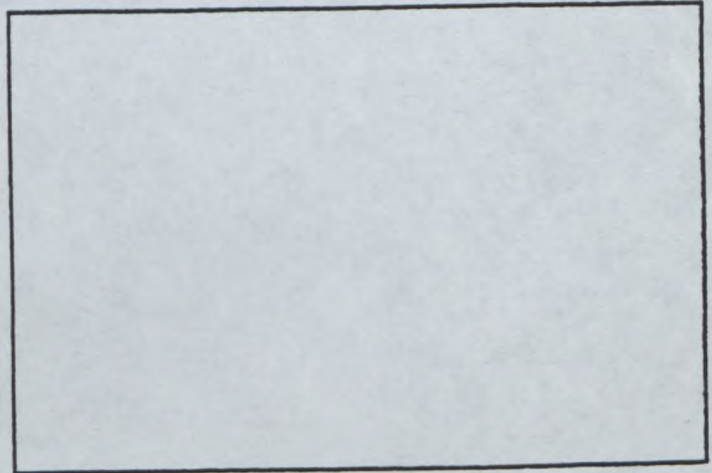

PHOTO No

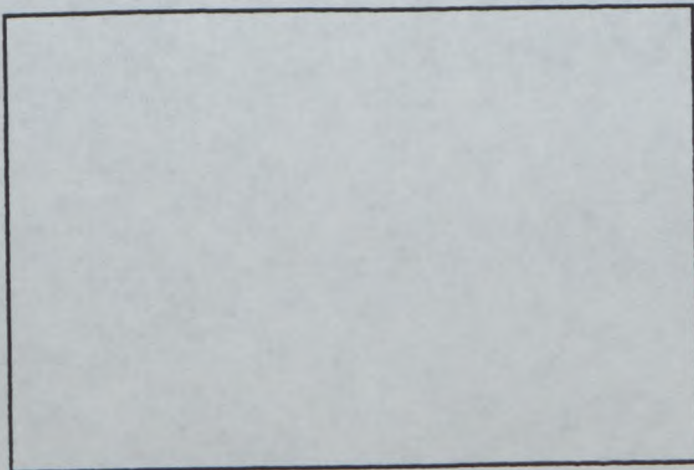
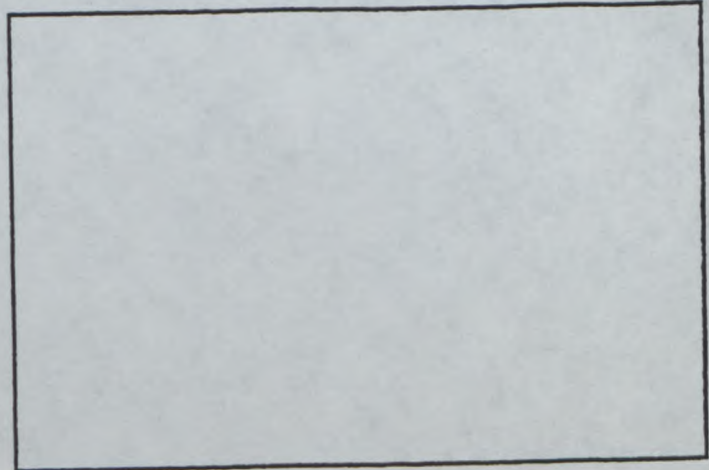

PHOTO No



Page ou ext. Page or ext.	Article Article	Description Description
02/02 V0		<ul style="list-style-type: none"> - Photo XVI mit korrigierten Abmessungen der Öffnungen / photo XVI with corrected dimensions of openings - Photo XVIII mit korrigierten Abmessungen der Öffnungen / photo XVIII with corrected dimensions of openings - Ergänzende Information: Zeichnung mit korrigierten Abmessungen der Dimensionen / complementary information: drawing with corrected dimensions of openings

photo XVI



openings see drawing: A B C D

photo XVIII



opening see drawing E

Q PA - FC - 1990 - 010.04.FB.11.94

FEDERATION INTERNATIONALE
DE L'AUTOMOBILE

8, place de la Concorde, 75008 Paris

Services Administratifs :

15, rue Boissy d'Anglas, 75008 Paris

Marque
Make

Audi

Modèle
Model

Audi A4

Homologation No

ST-017

Extension No

04 / 01 ER

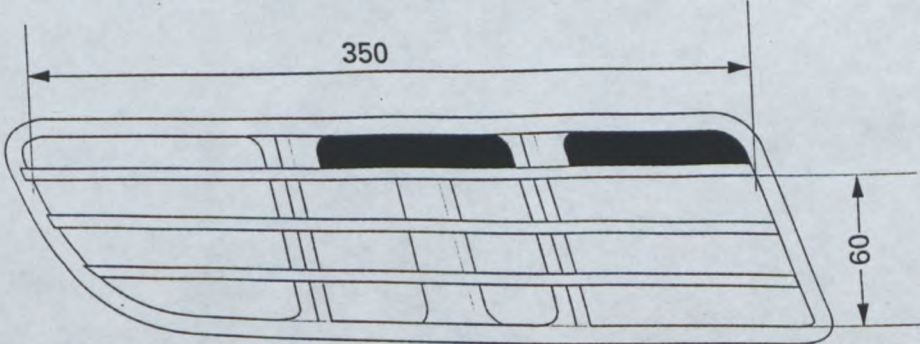
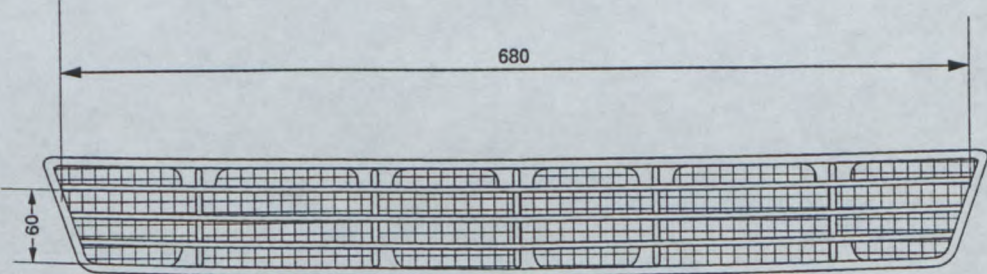
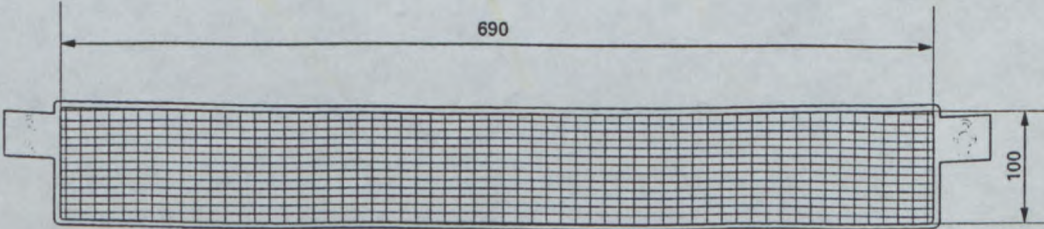
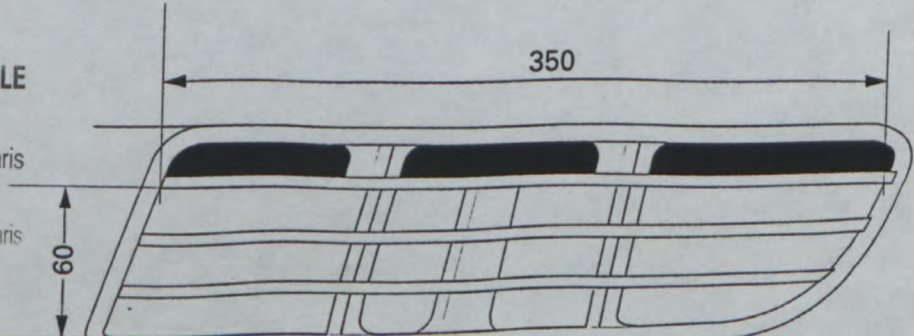
Page ou ext. Page or ext.	Article Article	Description Description
		<p data-bbox="1286 365 1517 398">Tolerances +/- 1 %</p> <p data-bbox="469 398 596 432">drawing A</p>  <p data-bbox="475 887 603 920">drawing B</p>  <p data-bbox="472 1328 600 1361">drawing C</p>  <p data-bbox="466 1727 593 1760">drawing D</p> 

Q FA - FC - 1990 - 010.04.FB.11.94

FEDERATION INTERNATIONALE
DE L'AUTOMOBILE

8, place de la Concorde, 75008 Paris

Services Administratifs :

Paris - rue Boissy d'Anglas, 75008 Paris

Page ou ext. Page or ext.	Article Article	Description Description
------------------------------	--------------------	----------------------------

drawing E

Tolerances +/- 1 %

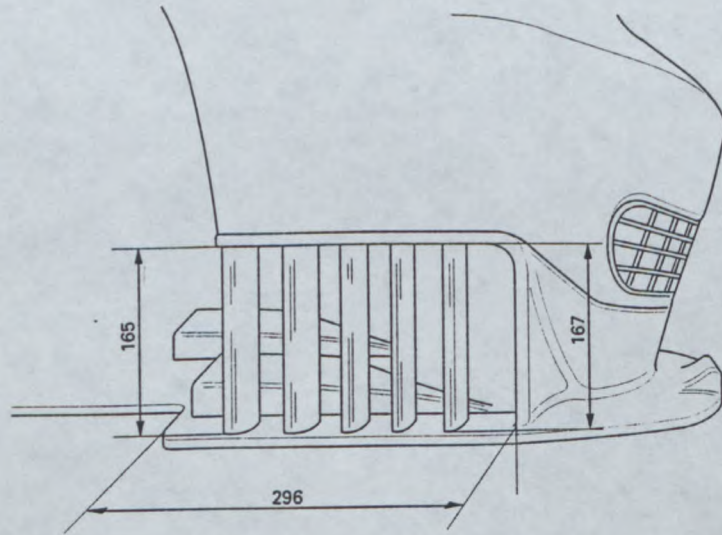

replacing drawing in complementary information

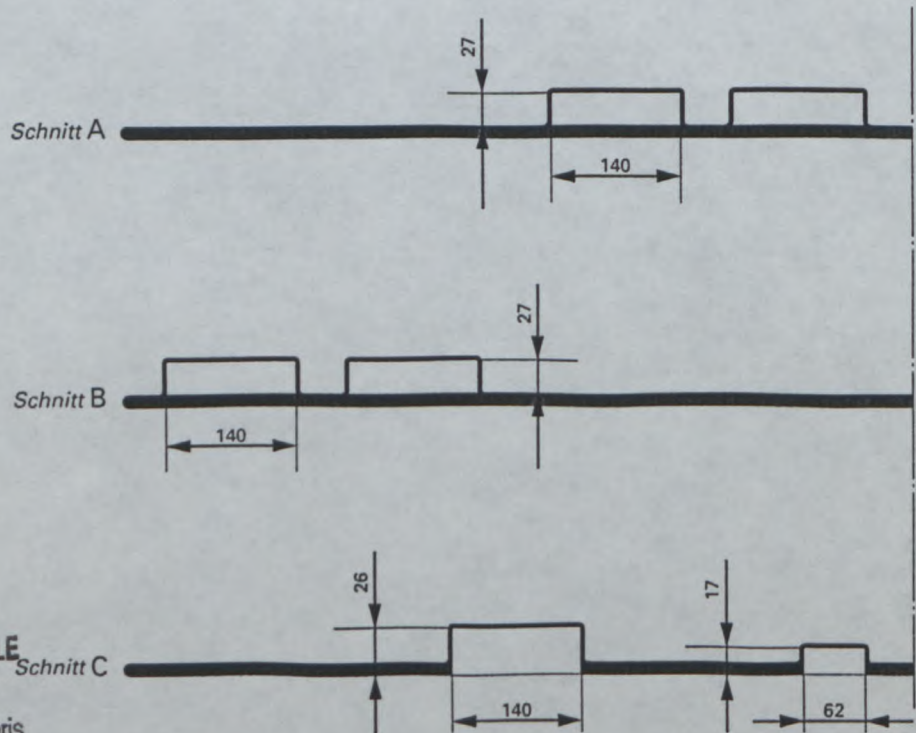

Q PIA - FC - 1990 - 010.04.FB.11.94

FEDERATION INTERNATIONALE
 DE L'AUTOMOBILE
 8, place de la Concorde, 75008 Paris
 Services Administratifs :
 8 bis, rue Boissy d'Angles, 75008 Paris



FEDERATION INTERNATIONALE
DE L'AUTOMOBILE

Homologation No

ST 17

Groupe
Group

A./B./N./T1/ Supertourisme
Supertouring

Extension No

05/02 ER

FICHE D'EXTENSION D'HOMOLOGATION
FORM OF HOMOLOGATION EXTENSION

- ES Evolution sportive du type / Sporting evolution of the
- ET Evolution normale du type / Normal evolution of the
- VF Variante de fourniture / Supply variant
- VO Variante option / Option variant
- ER Erratum / Erratum

Véhicule: Constructeur
Vehicle: Manufactureur

AUDI AG

Modèle et type
Model and type

Audi A4

Homologation valable à partir du
Homologation valid as from

01.07.1995

Page ou ext. Page or ext.	Article Article	Description Description
		<p>Replace the following dimensions :</p> <p>Art. 203 : 1737 , instead of 1753.</p> <p>Art. 204a : 1732 , instead of 1746.</p> <p>Art. 204b : 1712 , instead of 1725.</p>

FEDERATION INTERNATIONALE
DE L'AUTOMOBILE

8, place de la Concorde, 75008 Paris
Services Administratifs :
8 bis, rue Boissy d'Anglas, 75008 Paris



FEDERATION INTERNATIONALE
DE L'AUTOMOBILE

Homologation No

ST-017

Groupe
Group

~~A/B/N/T1~~

Supertourisme
Supertouring

Extension No

06/04 VO

FICHE D'EXTENSION D'HOMOLOGATION
FORM OF HOMOLOGATION EXTENSION

- ES Evolution sportive du type / Sporting evolution of the
- ET Evolution normale du type / Normal evolution of the
- VF Variante de fourniture / Supply variant
- VO Variante option / Option variant
- ER Erratum / Erratum

Véhicule: Constructeur
Vehicle: Manufactureur

AUDI AG

Modèle et type
Model and type

Audi A4

Homologation valable à partir du
Homologation valid as from

01 MARS 1996

Page ou ext. Page or ext.	Article Article	Description Description
6	902	<p>verstärkte Befestigungspunkte und Aufnahme des Fahrersitzes / reinforced mounting points and supports of drivers seat</p> <p style="text-align: right;">PHOTO 1 - 5</p>

© FIA - FC - 1990 - 01004.FIL1194

FEDERATION INTERNATIONALE
DE L'AUTOMOBILE

8, place de la Concorde, 75008 Paris

Services Administratifs :

8 bis, rue Boissy d'Anglas, 75008 Paris

Marque
Make

Audi

Modèle
Model

Audi A4

Homologation No

ST-017

Extension No

06/04 VO

PHOTO No 1

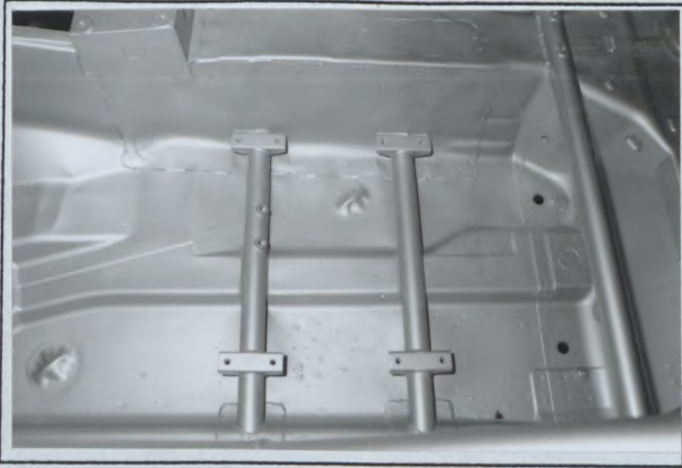

PHOTO No 2

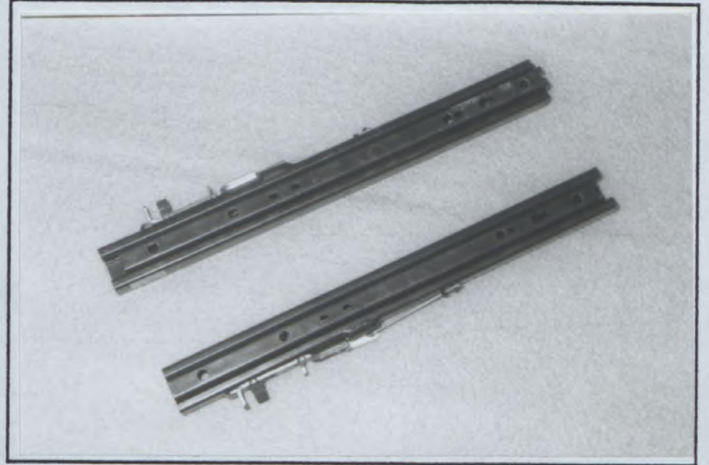

PHOTO No 3

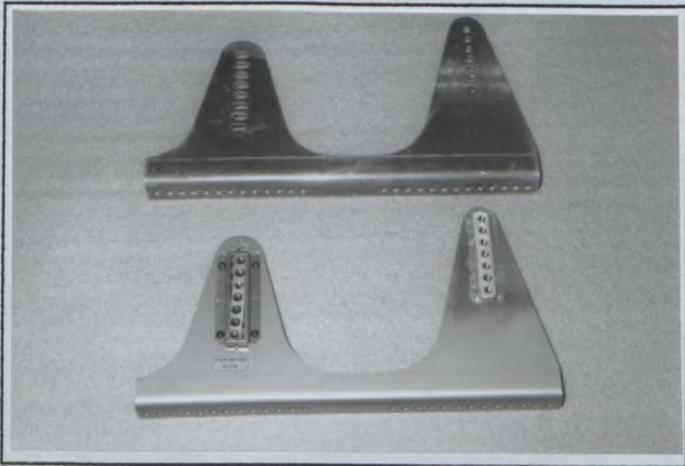

PHOTO No 4

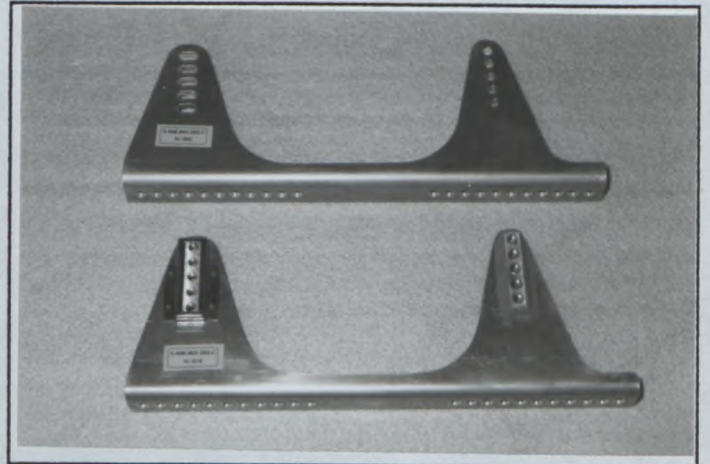

PHOTO No 5

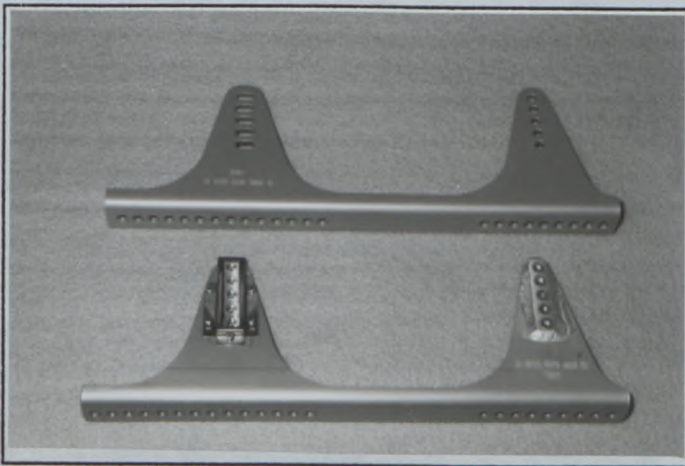
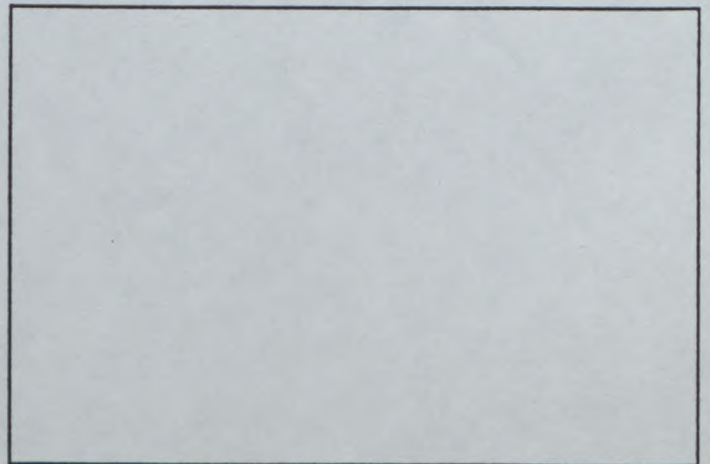

PHOTO No





FEDERATION INTERNATIONALE DE L'AUTOMOBILE

Homologation N°

ST-017

Extension N°

07/05 VO

VO

FICHE D'EXTENSION D'HOMOLOGATION POUR DISPOSITIFS AERODYNAMIQUES EN SUPERTOURISME
HOMOLOGATION EXTENSION FORM FOR AERODYNAMIC DEVICES IN SUPER TOURING

Homologation valable à partir du
Homologation valid as from

01 AVR. 1996

Véhicule : Constructeur
Vehicle: Manufacturer

AUDI AG

Modèle et type
Model and type

Audi A4

A) Voiture vue de 3/4 avant
Car seen from 3/4 front



B) Voiture vue de 3/4 arrière
Car seen from 3/4 rear

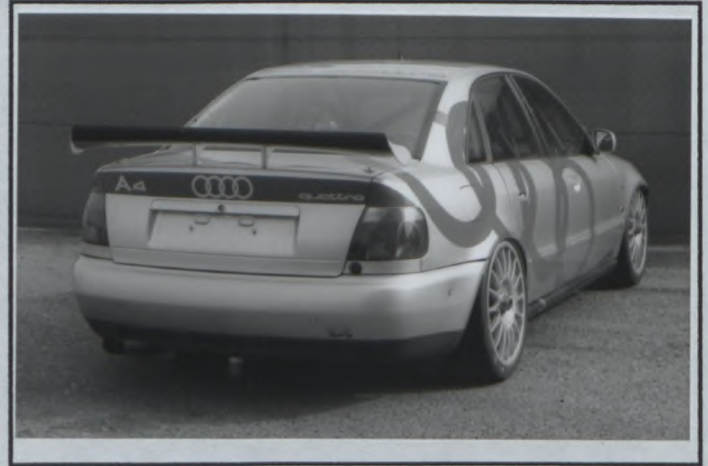

9. CARROSSERIE / BODYWORK

XVI) DISPOSITIF AVANT DEPOSE ET VU DE FACE AVEC DIMENSIONS DES OUVERTURES :
DISMOUNTED FRONT DEVICE SEEN FROM FRONT WITH DIMENSIONS OF OPENINGS:



openings see drawing:

A

B

C

D

FEDERATION INTERNATIONALE DE L'AUTOMOBILE

8, place de la Concorde, 75008 Paris

Services Administratifs :

8 bis, rue Boissy d'Anglas, 75008 Paris

Marque
Make

Audi

Modèle
Model

Audi A4

Homologation N°

ST-017

Extension N°

07 / 05 V0

XVIII) DISPOSITIF AVANT DEPOSE ET VU DE COTE AVEC DIMENSIONS DES OUVERTURES :
DISMOUNTED FRONT DEVICE IN SIDE VIEW WITH DIMENSIONS OF OPENINGS:

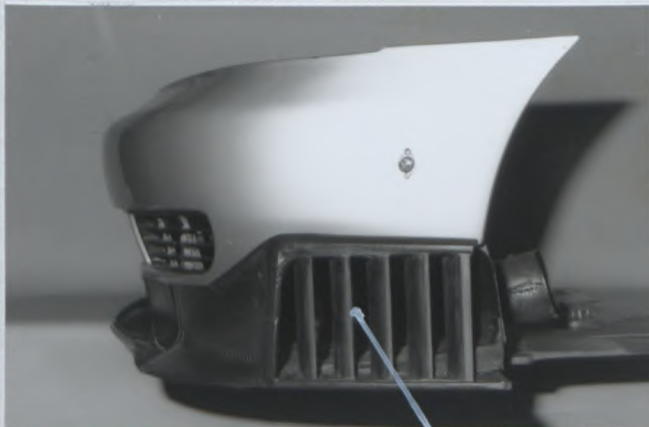

openings see drawing: E

XXIII) DISPOSITIF AVANT EN PLACE ET VU DE FACE :
MOUNTED FRONT DEVICE SEEN FROM FRONT:



XXIV) DISPOSITIF AVANT EN PLACE ET VU DE COTE :
MOUNTED FRONT DEVICE IN SIDE VIEW:



FEDERATION INTERNATIONALE
DE L'AUTOMOBILE

8, place de la Concorde, 75008 Paris
Services Administratifs

8 bis, rue Boissy d'Anglas, 75008 Paris

XVII) DISPOSITIF ARRIERE EN PLACE
ET VU DE COTE :
MOUNTED REAR DEVICE IN SIDE VIEW:

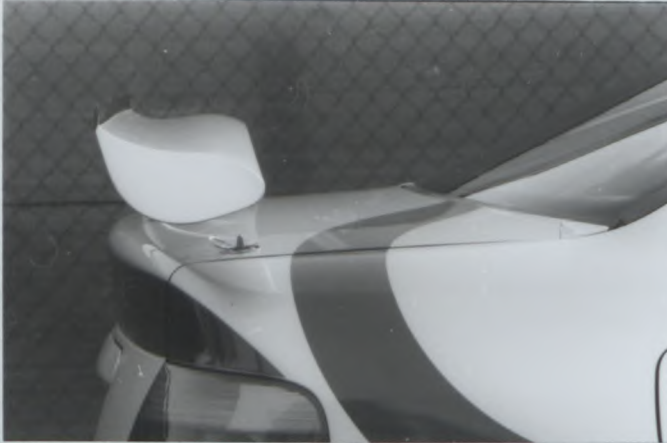

XIX) SECTION DU DISPOSITIF ARRIERE AU
NIVEAU DE L'AXE LONGITUDINAL DE LA
VOITURE :
SECTION OF REAR DEVICE AT CAR'S
CENTERLINE LEVEL:

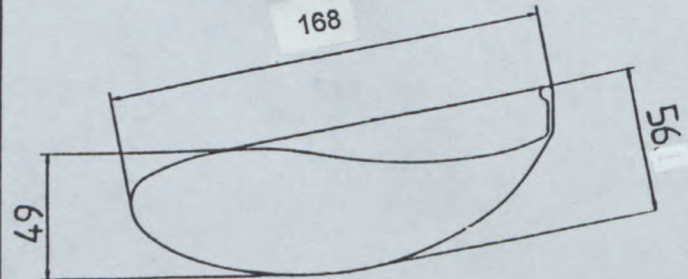

XX) DISPOSITIF ARRIERE EN PLACE ET VU DE DESSUS :
MOUNTED REAR DEVICE SEEN FROM ABOVE:



XXI) DISPOSITIF ARRIERE DEPOSE ET
VU DE COTE :
DISMOUNTED REAR DEVICE IN SIDE VIEW:



Marque
Make

Audi

Modèle
Model

Audi A4

Homologation N°

ST-017

Extension N°

07/05 V0

XXII) DISPOSITIF ARRIERE DEPOSE ET VU DE DESSUS :
DISMOUNTED REAR DEVICE SEEN FROM ABOVE:

tolerances $\pm 1\%$

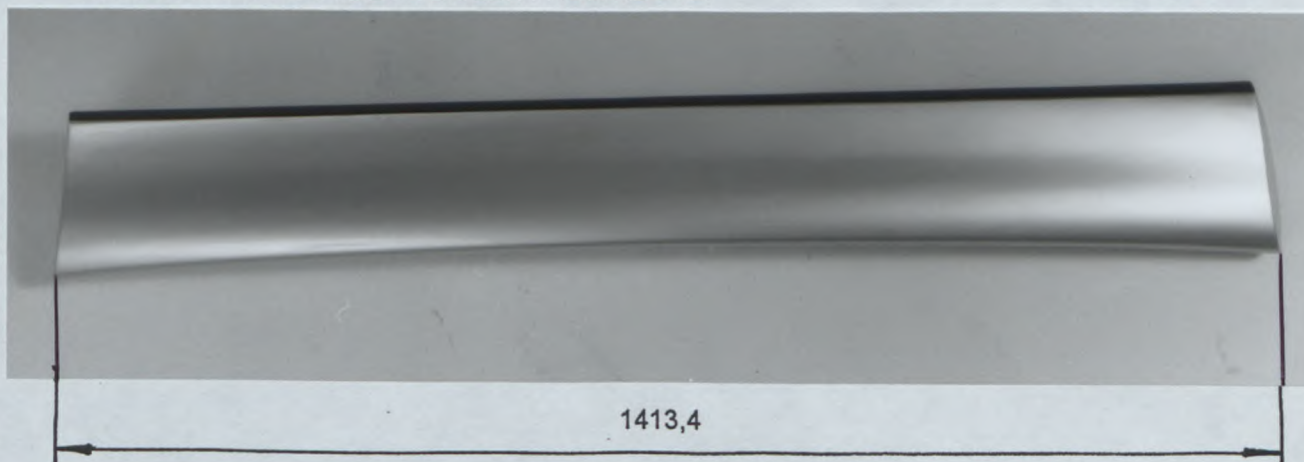

902. Extérieur : p) Angle entre dispositif arrière et carrosserie $16,5^\circ \pm 1^\circ$
Exterior: Angle between rear device and bodywork



INFORMATIONS COMPLEMENTAIRES / COMPLEMENTARY INFORMATION :

902. p) Angle between rear device and bodywork is measured in position shown on this drawing

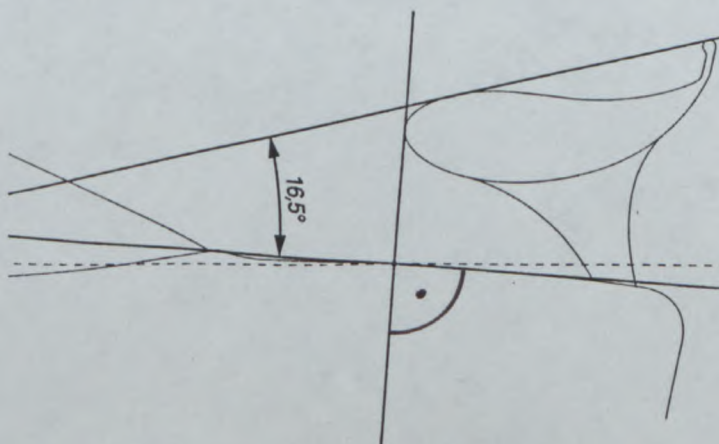

FEDERATION INTERNATIONALE
DE L'AUTOMOBILE

8, place de la Concorde, 75008 Paris
Services Administratifs :
8 bis, rue Boissy d'Anglas, 75008 Paris

Marque
Make

Audi

Modèle
Model

Audi A4

Homologation No

ST-017

Extension No

07/05 V0

Page ou ext.
Page or ext.

Article
Article

Description
Description

drawing A

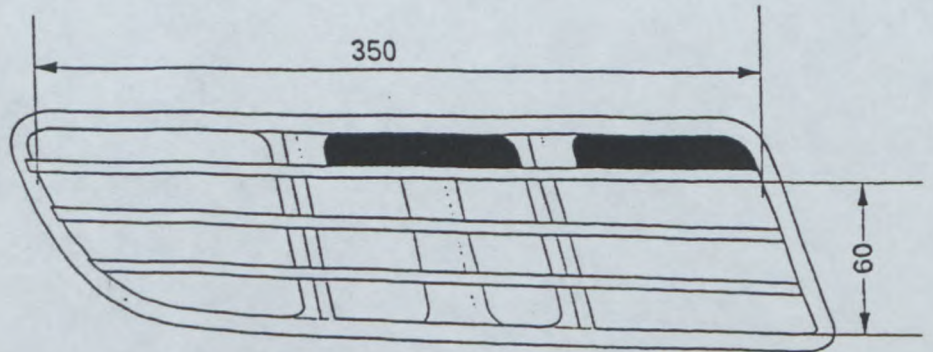

drawing B

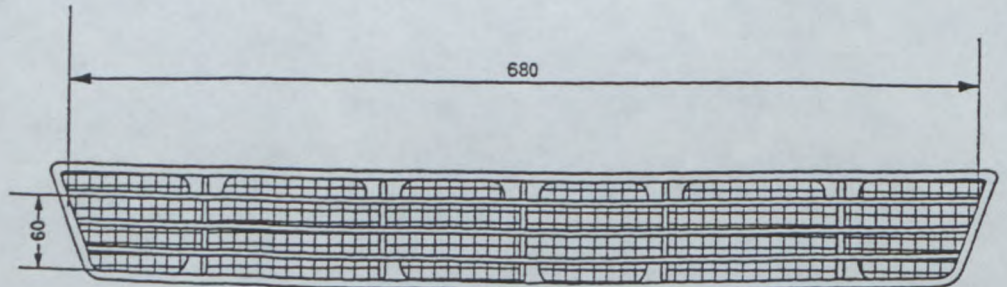

drawing C

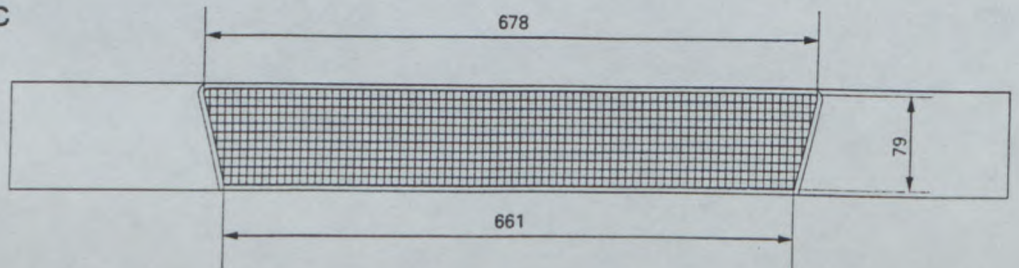

drawing D

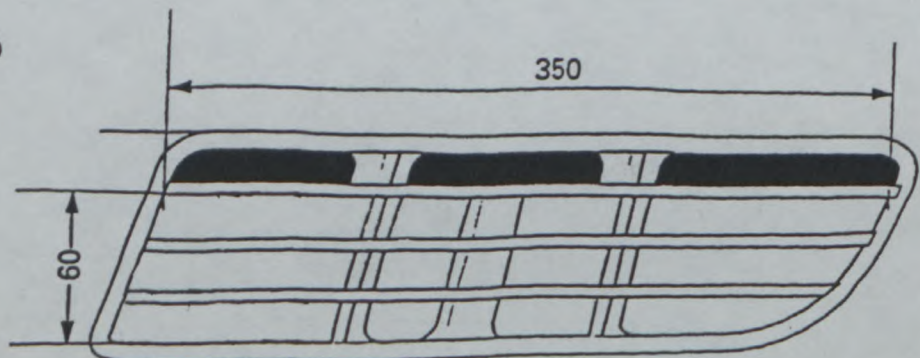

FEDERATION INTERNATIONALE
DE L'AUTOMOBILE

8, place de la Concorde, 75008 Paris

Services Administratifs :

8 bis, rue Boissy d'Angas, 75008 Paris

Marque
Make

Audi

Modèle
Model

Audi A4

Homologation No

ST-017

Extension No

07/05 V0

Page ou ext.
Page or ext.

Article
Article

Description
Description

drawing E

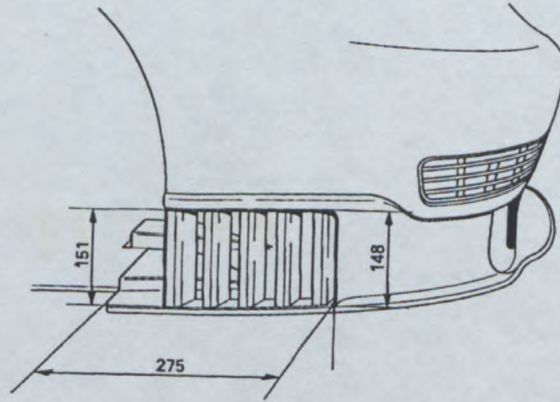
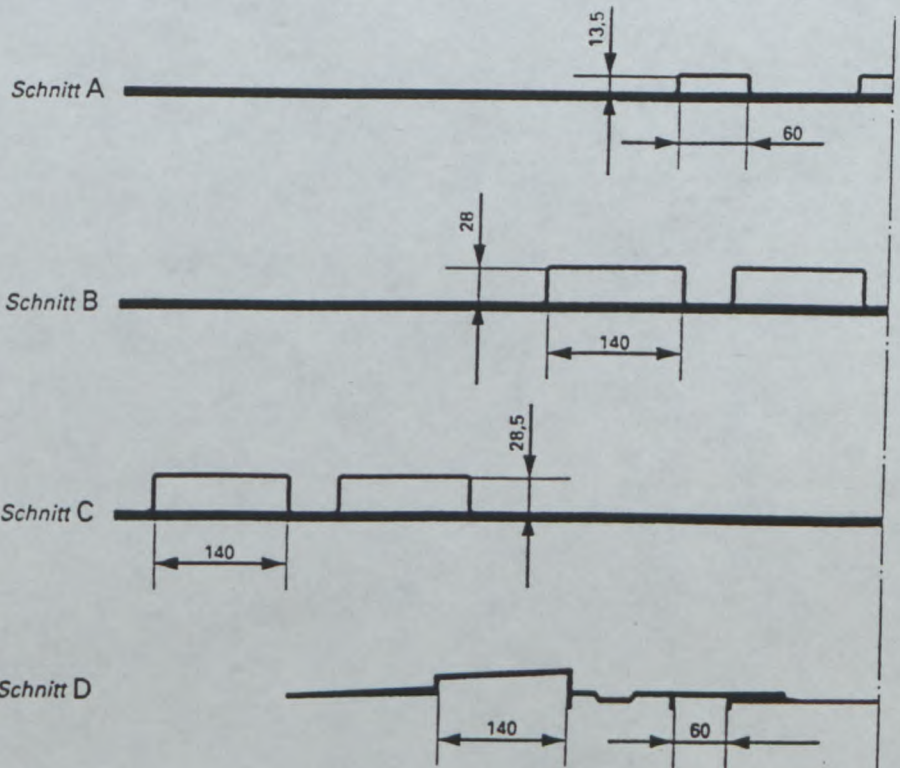
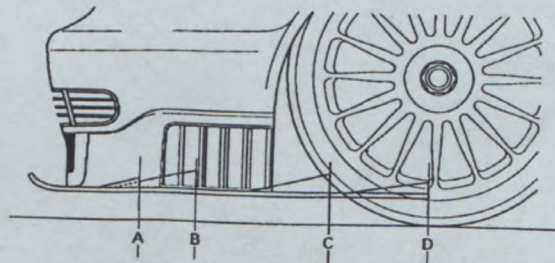

Photo XVIII: inside engine compartment mounted airducts on the plate for air exhaust



tolerances $\pm 1\%$

FEDERATION INTERNATIONALE
DE L'AUTOMOBILE

8, place de la Concorde, 75008 Paris

Services Administratifs :

8 bis, rue Boissy d'Anglas, 75008 Paris



FEDERATION INTERNATIONALE
DE L'AUTOMOBILE

Homologation No

ST-017

Groupe
Group

~~A/B/N/T~~

Supertourisme
Supertouring

Extension No

08/06 VO

FICHE D'EXTENSION D'HOMOLOGATION POUR ARMATURE DE SECURITE
FORM OF HOMOLOGATION EXTENSION FOR SAFETY CAGE

VO Variante option / Option variant

Véhicule: Constructeur AUDI AG Modèle et type Audi A4
Vehicle: Manufactureur AUDI AG Model and type Audi A4

Homologation valable à partir du 01 AVR. 1996
Homologation valid as from 01 AVR. 1996

	Arceau principal Main rollbar	Entretoise longitudinale Longitudinal strut	Entretoise diagonale Diagonal Strut	Arceau avant Front rollbar
Matériau Material	<u>Stahl / steel</u>	<u>Stahl / steel</u>	<u>Stahl / steel</u>	<u>Stahl / steel</u>
Diamètre extérieur Exterior diameter	<u>40</u> mm	<u>40</u> mm	<u>40</u> mm	<u>40</u> mm
Epaisseur de paroi Wall thickness	<u>1,5</u> mm	<u>1,5</u> mm	<u>1,0</u> mm	<u>1,0</u> mm
Limite élastique Elastic limit	<u>600</u> daN/mm ²	<u>600</u> daN/mm ²	<u>600</u> daN/mm ²	<u>600</u> daN/mm ²
Résistance à la traction Tensile strength	<u>700 - 820</u> daN/mm ²	<u>700 - 820</u> daN/mm ²	<u>700 - 820</u> daN/mm ²	<u>700 - 820</u> daN/mm ²

Fabricant de l'armature Winfried Matter GmbH Poids total y compris les fixations 43,5 kg
Structure manufacturer Winfried Matter GmbH Total weight including fixations 43,5 kg

Armature complète hors de la voiture
Complete structure outside the car

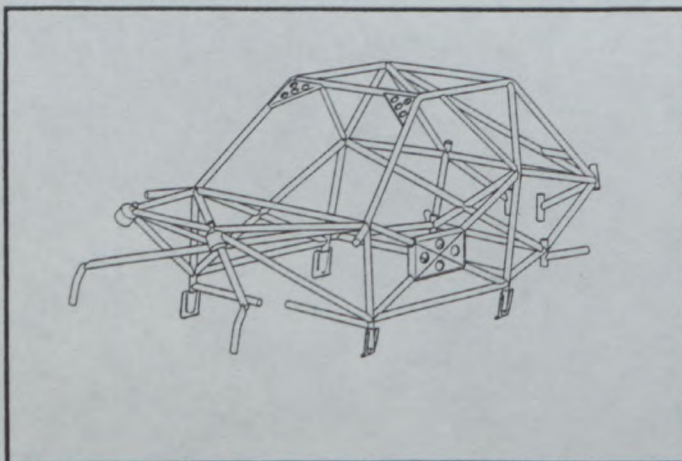

Nous attestons que la présente armature de sécurité répond aux dispositions de l'Annexe J de la FIA, en particulier en ce qui concerne ses implantations, ses connexions, et ses résistances aux contraintes.

We certify that the present safety structure complies with the conditions of the FIA Appendix J, in particular with regard to its attachments, its connections, and its stress resistances.

Signature du représentant du constructeur du véhicule
Signature of the car manufacturer representative

AUDI AG
- Audi Sport - FEDERATION INTERNATIONALE
DE L'AUTOMOBILE

[Signature]
i. V. *[Signature]* 8, place de la Concorde, 75008 Paris
Dr. W. Ullrich Services Administratifs :
8 bis, rue Boissy d'Anglas, 75008 Paris

Marque
Make

Audi

Modèle
Model

Audi A4

Homologation No

ST-017

Extension No

08/06 VO

PHOTO No 1

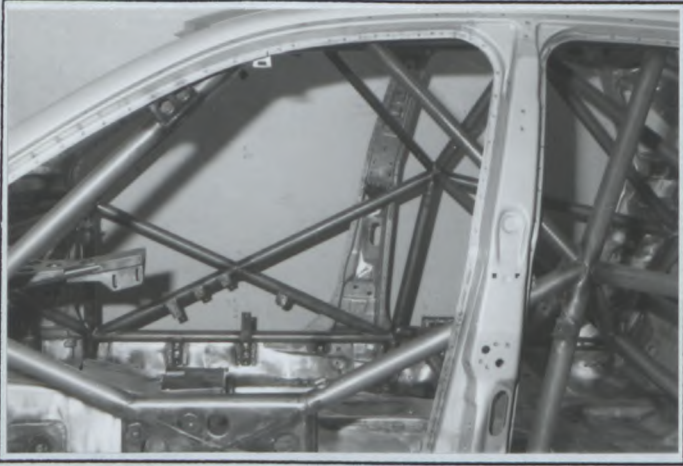

PHOTO No 2

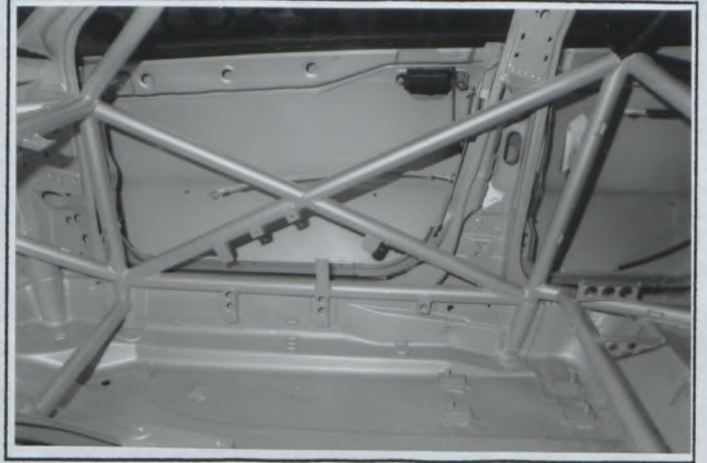

PHOTO No 3

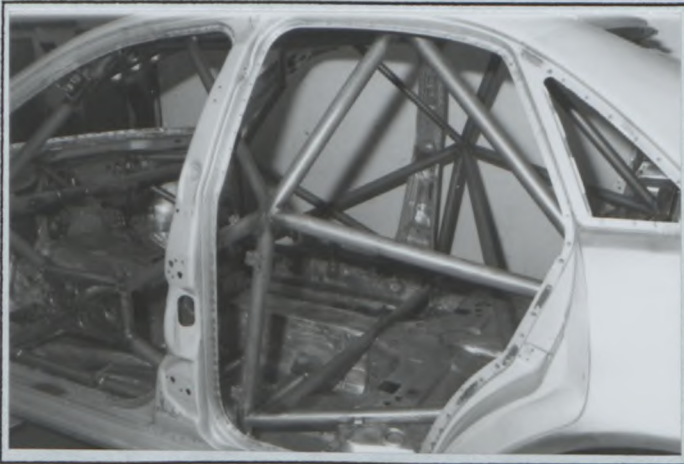

PHOTO No 4

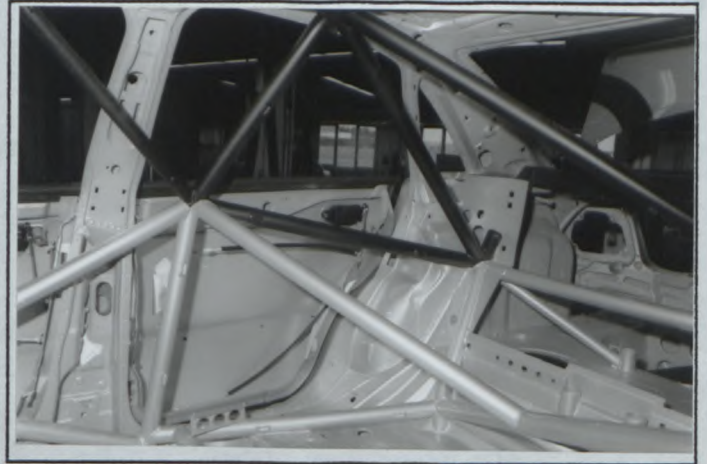

PHOTO No 5

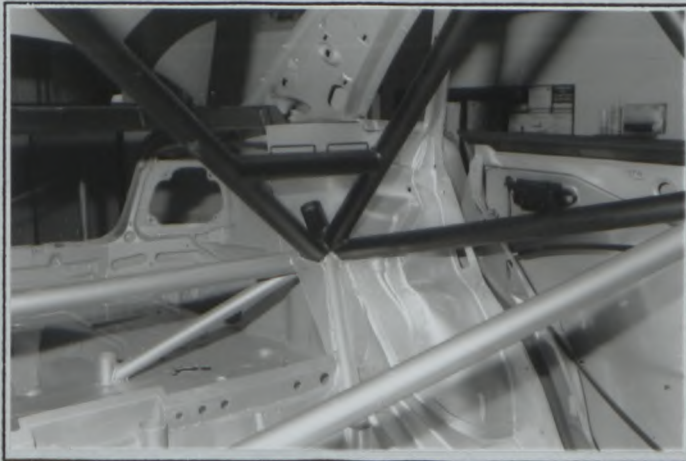

PHOTO No 6

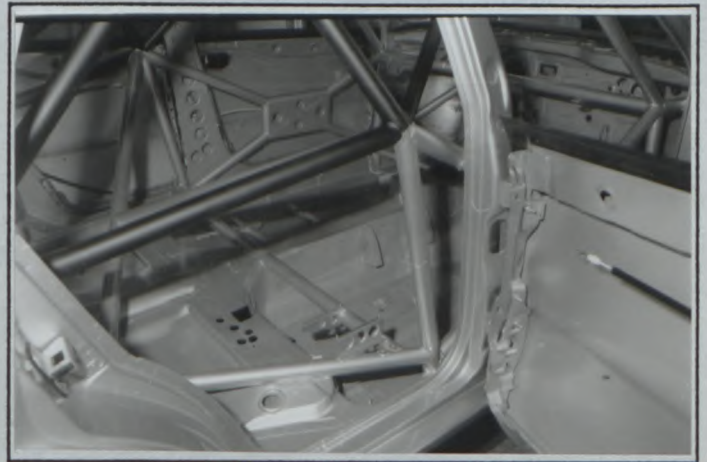

PHOTO No 7

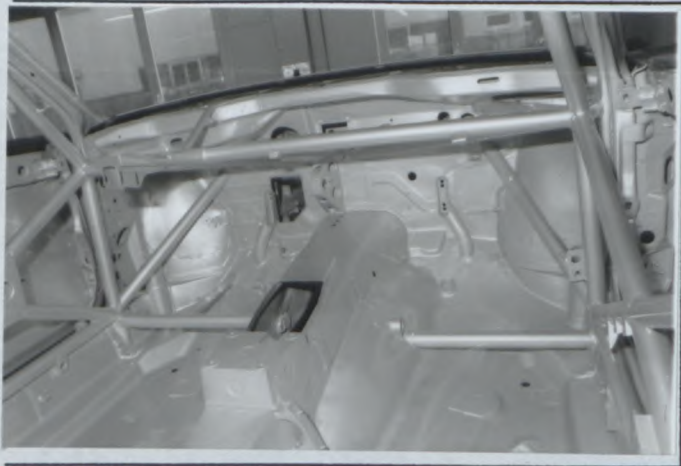

PHOTO No 8

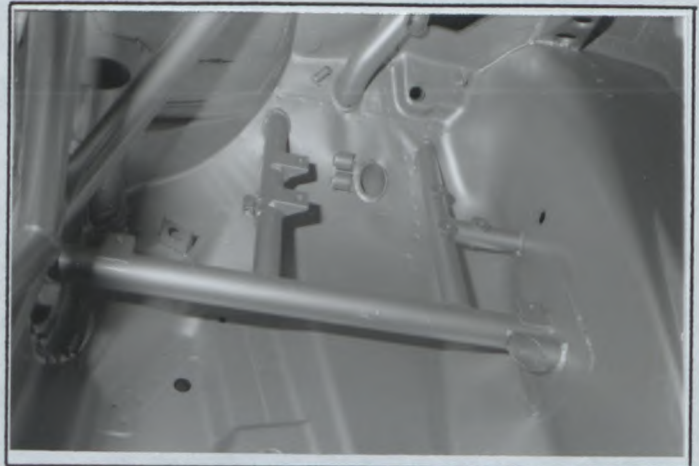

PHOTO No 9

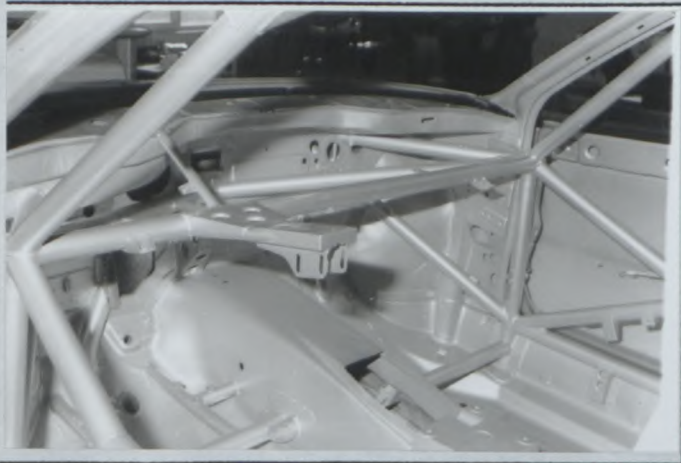

PHOTO No 10

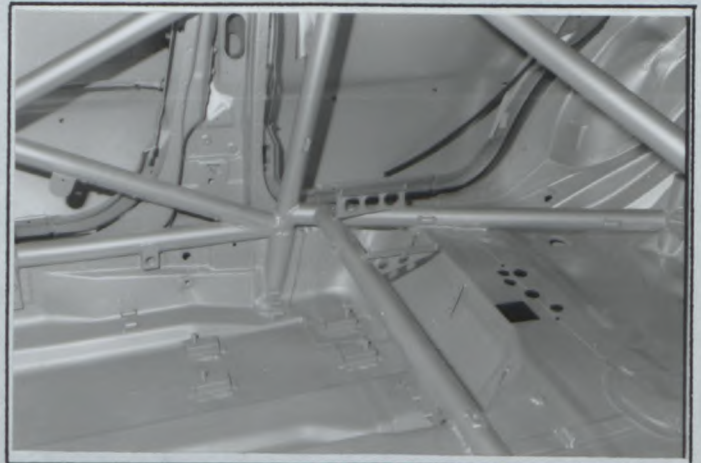
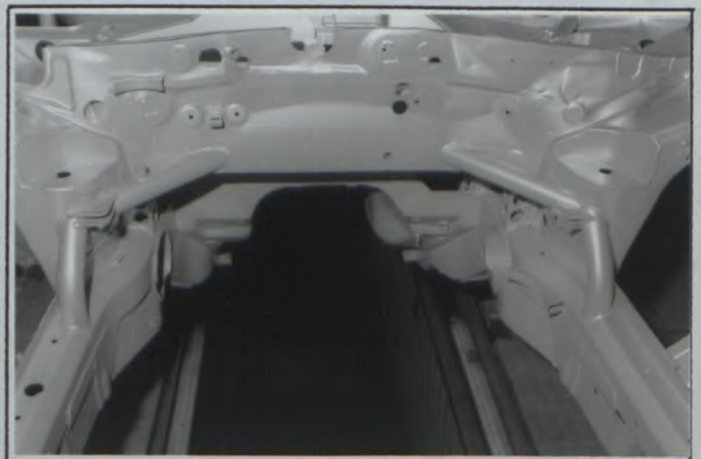

PHOTO No 11



PHOTO No 12



Marque / make Audi

Modèle / Model Audi A4

ST-017

Extension No
08 / 0 6 V 0

PHOTO No 13

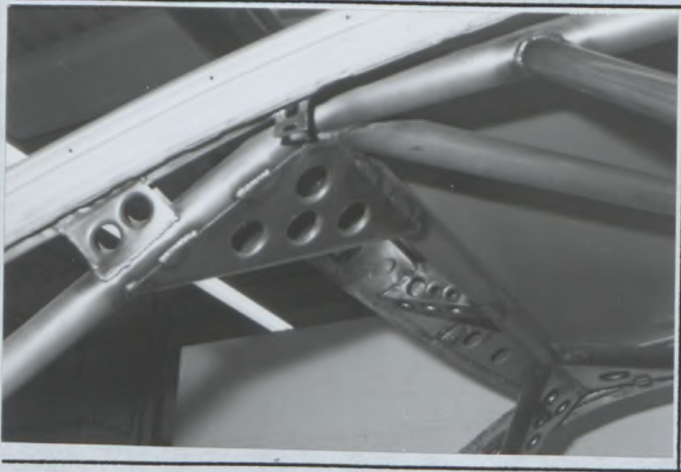

PHOTO No 14

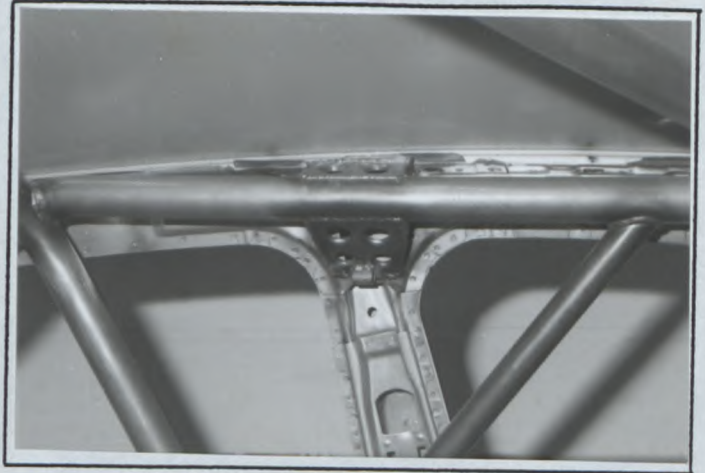

PHOTO No

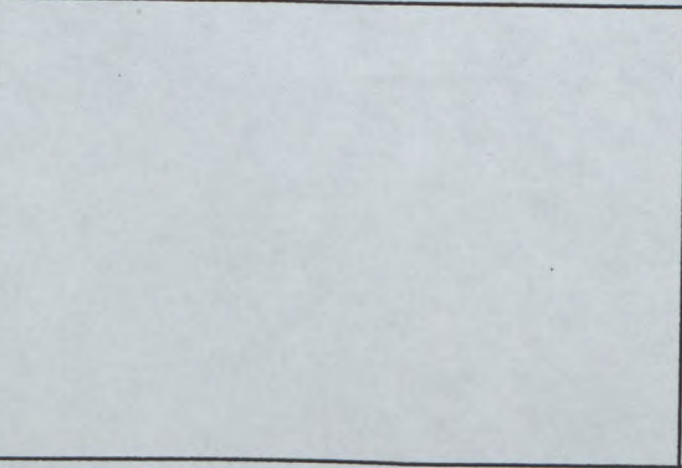

PHOTO No

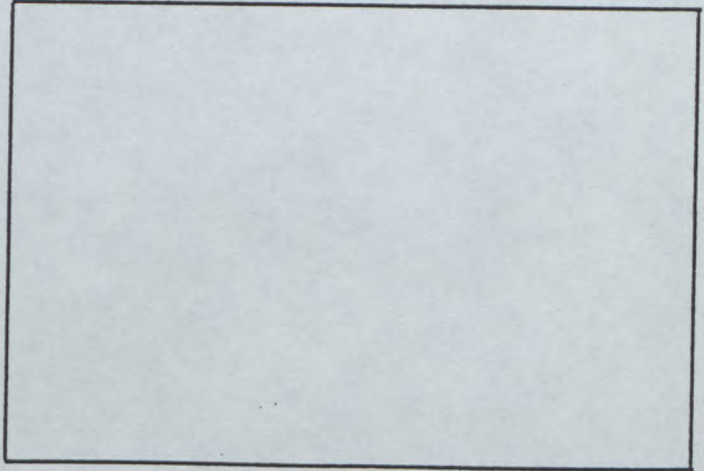

PHOTO No

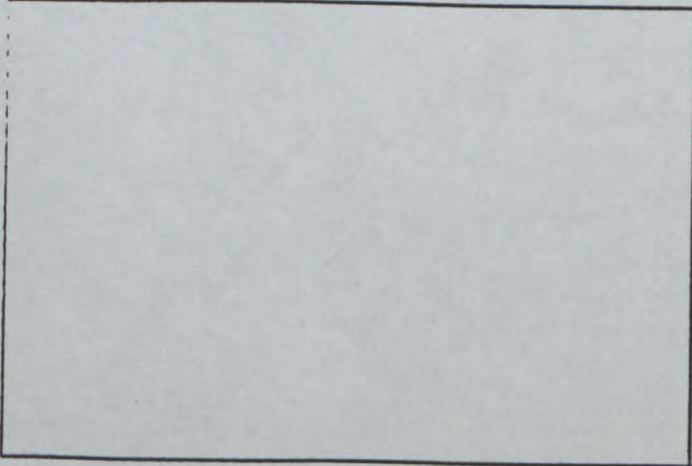
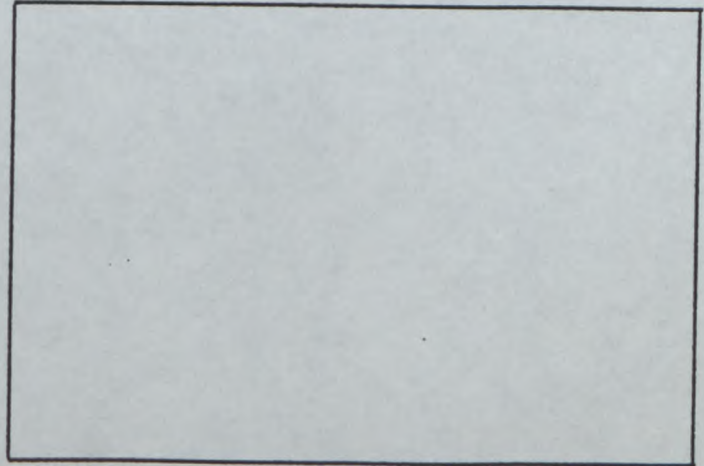

PHOTO No





FEDERATION INTERNATIONALE DE L'AUTOMOBILE

Homologation No

ST-17

Groupe Group

A/B/N/T1/Supertourisme Supertouring

Extension No

09/03 ER

FICHE D'EXTENSION D'HOMOLOGATION FORM OF HOMOLOGATION EXTENSION

- ES Evolution sportive du type / Sporting evolution of the
ET Evolution normale du type / Normal evolution of the
VF Variante de fourniture / Supply variant
VO Variante option / Option variant
ER Erratum / Erratum

Vehicule: Constructeur AUDI AG
Vehicule: Manufactureur
Modele et type Audi A4
Model and type

Homologation valable a partir du 01 AVR. 1996
Homologation valid as from

Table with 3 columns: Page ou ext., Article, Description. Row 1: Page 5, Article 7, drawing of front suspension: [Technical drawing of front suspension]

FEDERATION INTERNATIONALE DE L'AUTOMOBILE

8, place de la Concorde, 75008 Paris
Services Administratifs:
his, rue Boissy d'Anglas, 75008 Paris

Handwritten signature

PA - FC - 1990 - 010.04.FB.11.94

Page ou ext. Page or ext.	Article Article	Description Description
------------------------------	--------------------	----------------------------

Page 5

7

drawing of rear suspension:

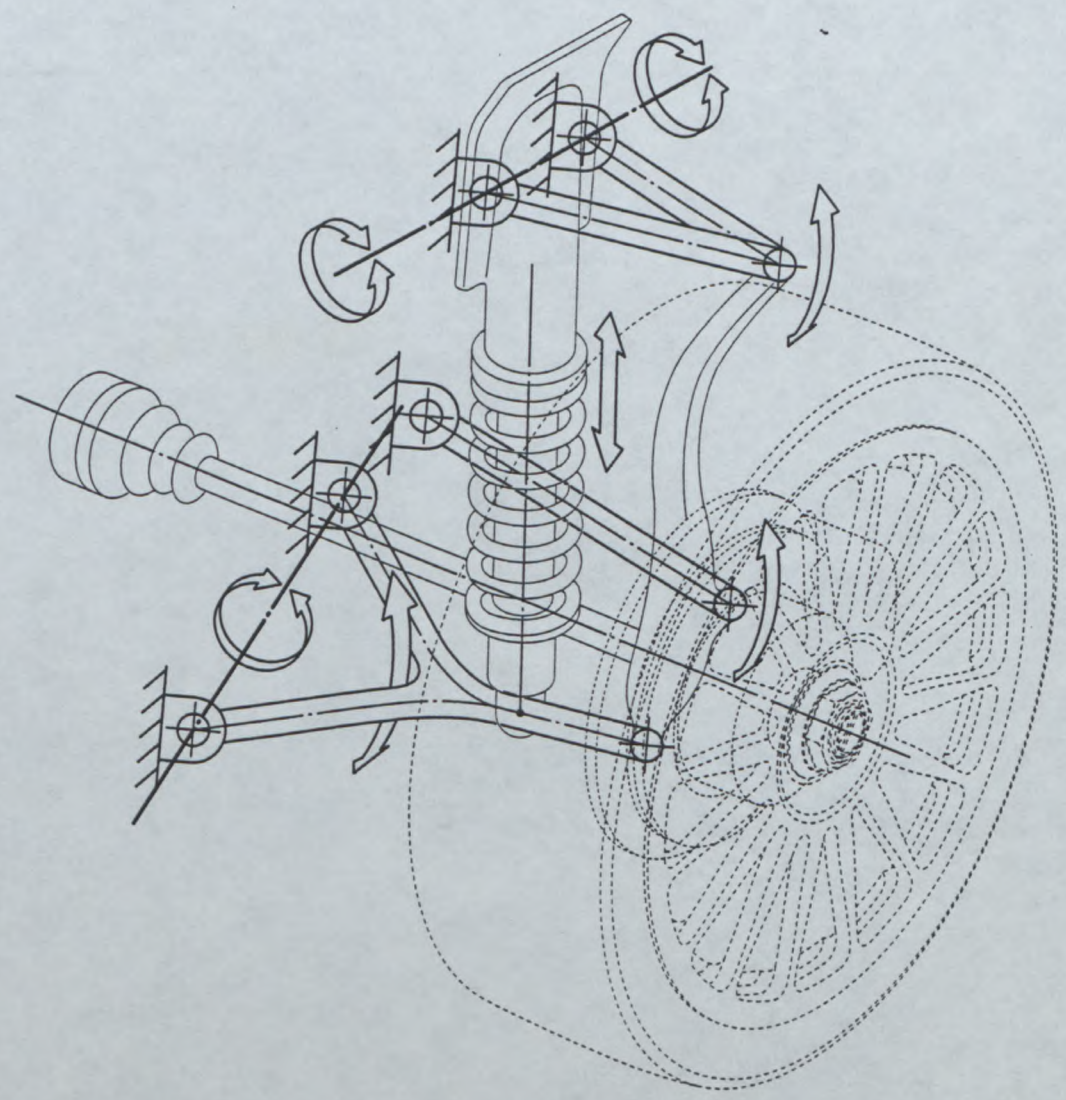



FEDERATION INTERNATIONALE DE L'AUTOMOBILE

Homologation No

ST-017

Groupe Group

~~XX~~~~B~~~~N~~~~XX~~~~A~~ / Supertourisme Supertouring

Extension No

10/01VF

FICHE D'EXTENSION D'HOMOLOGATION FORM OF HOMOLOGATION EXTENSION

- ES Evolution sportive du type / Sporting evolution of the
- ET Evolution normale du type / Normal evolution of the
- VF Variante de fourniture / Supply variant
- VO Variante option / Option variant
- ER Erratum / Erratum

Véhicule: Constructeur Audi AG Modèle et type Audi A4
Vehicle: Manufactureur Model and type

Homologation valable à partir du 01 MARS 1997
Homologation valid as from

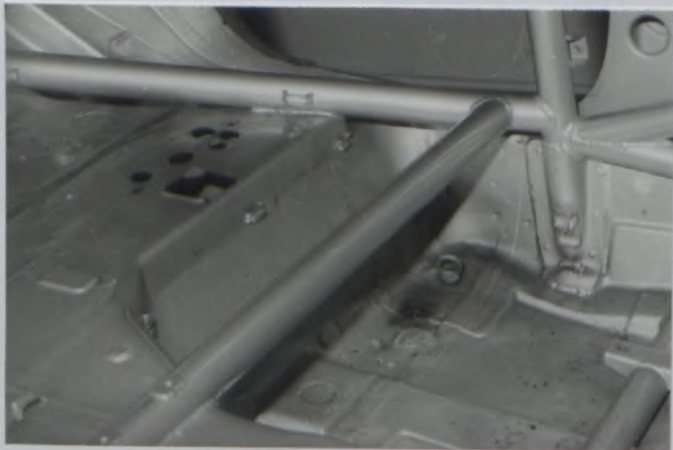
Page ou ext. Page or ext.	Article Article	Description Description
08/06	VO	<p>Safety cage: Wahlweise mit oder ohne Knotenblech / optional with or without connection plate with:</p>  <p>without:</p> 

FIA - FC - 1990 - 010.04.FB.11.94

fladys
FEDERATION INTERNATIONALE DE L'AUTOMOBILE
8, place de la Concorde, 75008 Paris
Services Administratifs :
8 bis, rue Boissy d'Anglas, 75008 Paris



FEDERATION INTERNATIONALE
DE L'AUTOMOBILE

Homologation No

ST-017

Groupes
Group

~~A~~/~~B~~/~~N~~/~~T~~/~~X~~ Supertourisme
Supertouring

Extension No

11/07 VO

FICHE D'EXTENSION D'HOMOLOGATION POUR ARMATURE DE SECURITE
FORM OF HOMOLOGATION EXTENSION FOR SAFETY CAGE

VO Variante option / Option variant

Véhicule: Constructeur Audi AG Modèle et type Audi A4
Vehicle: Manufactureur Model and type

Homologation valable à partir du 01 MARS 1997
Homologation valid as from

	Arceau principal Main rollbar	Entretoise longitudinale Longitudinal strut	Entretoise diagonale Diagonal Strut	Arceau avant Front rollbar
Matériau Material	Stahl/steel	Stahl/steel	Stahl/steel	Stahl/steel
Diamètre extérieur Exterior diameter	40 mm	40 mm	40 mm	40 mm
Epaisseur de paroi Wall thickness	1,5 mm	1,5 mm	1,0/0,8 mm	1,0 mm
Limite élastique Elastic limit	60 daN/mm ²	60 daN/mm ²	60 daN/mm ²	60 daN/mm ²
Résistance à la traction Tensile strength	70-82 daN/mm ²	70-82 daN/mm ²	70-82 daN/mm ²	70-82 daN/mm ²

all tubes are welded
Matter Motorsport GmbH

Fabricant de l'armature Poids total y compris les fixations 43,5 kg
Structure manufacturer Total weight including fixations

Armature complète hors de la voiture
Complete structure outside the car

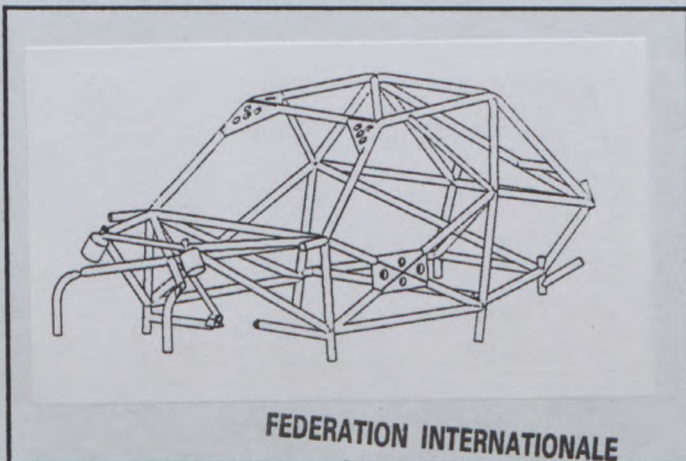

Nous attestons que la présente armature de sécurité répond aux dispositions de l'Annexe J de la FIA, en particulier en ce qui concerne ses implantations, ses connexions, et ses résistances aux contraintes.

We certify that the present safety structure complies with the conditions of the FIA Appendix J, in particular with regard to its attachments, its connections, and its stress resistances.

Signature du représentant du constructeur du véhicule
Signature of the car manufacturer representative

Audi AG
- Audi Sport -

i.V.
H.-P. Gassen

PHOTO No 1

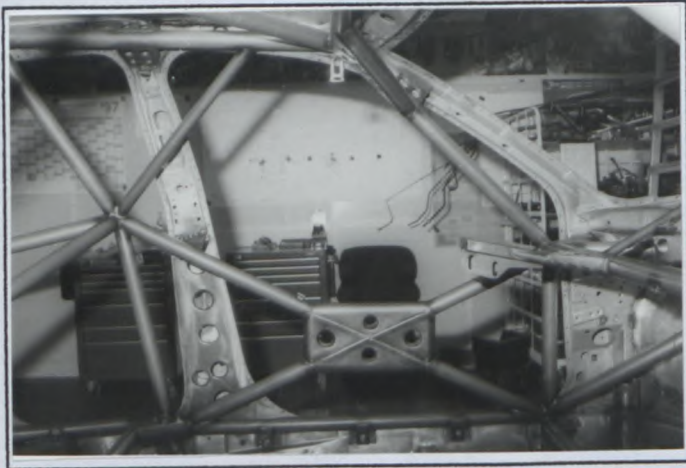

PHOTO No 2

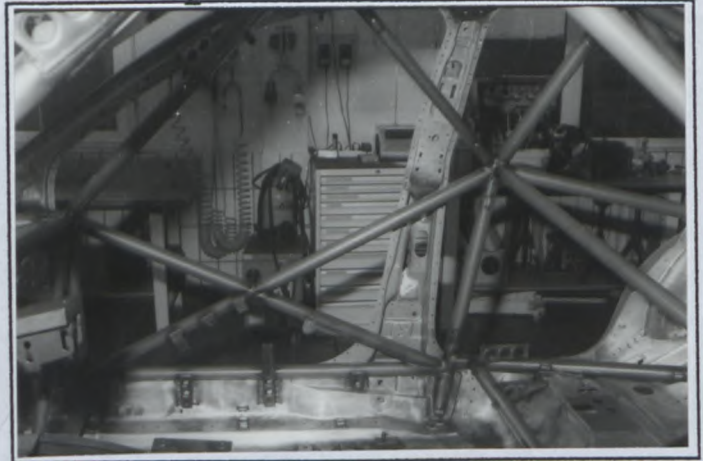

PHOTO No 3

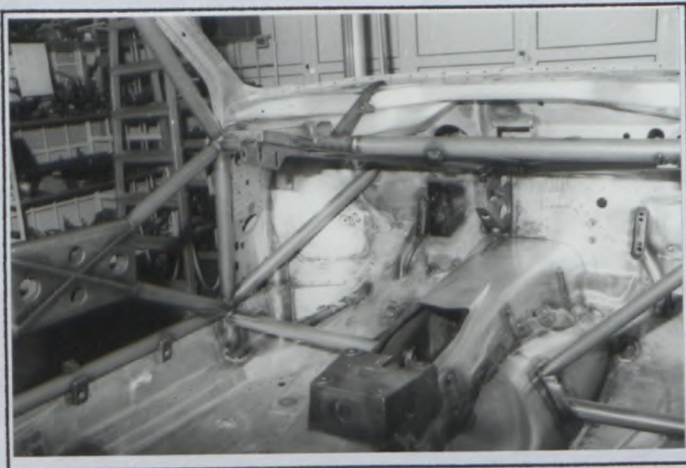

PHOTO No 4



PHOTO No 5



PHOTO No 6

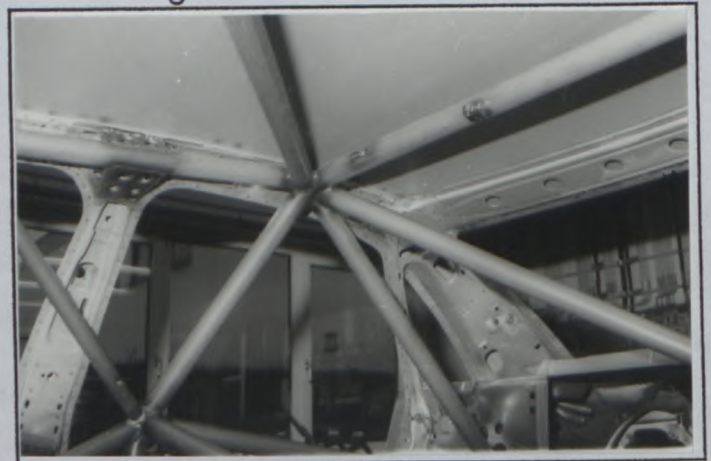

FEDERATION INTERNATIONALE
DE L'AUTOMOBILE

8, place de la Concorde, 75008 Paris

Services Administratifs :

8 bis, rue Boissy d'Anglas, 75008 Paris

PHOTO No 7

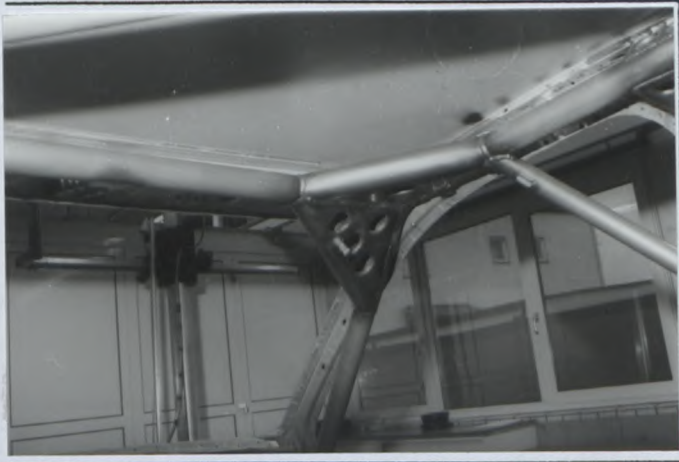

PHOTO No 8



PHOTO No 9

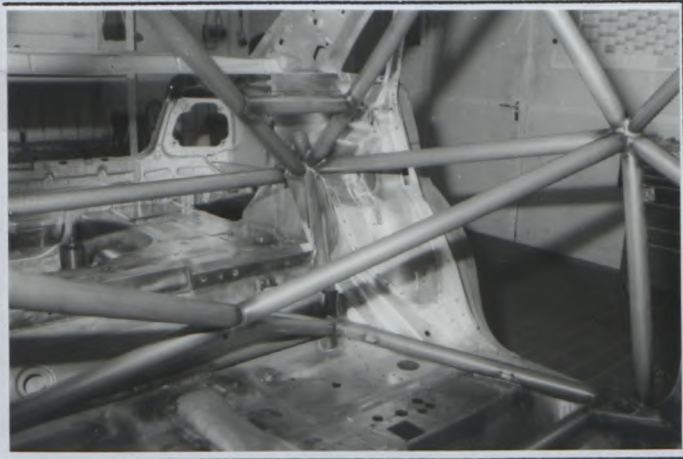

PHOTO No 10

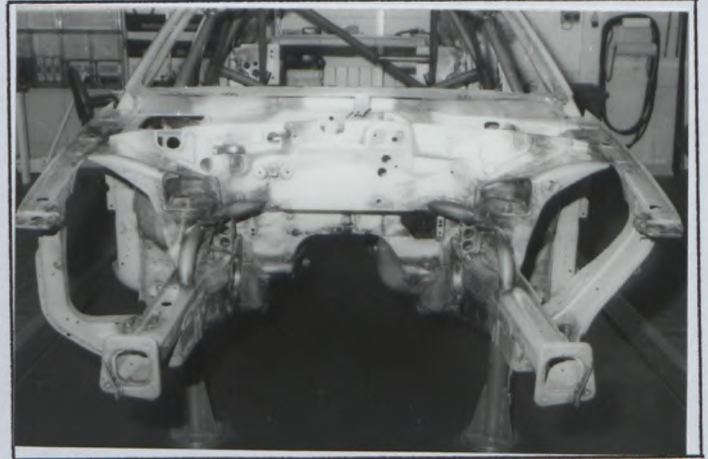

PHOTO No 11

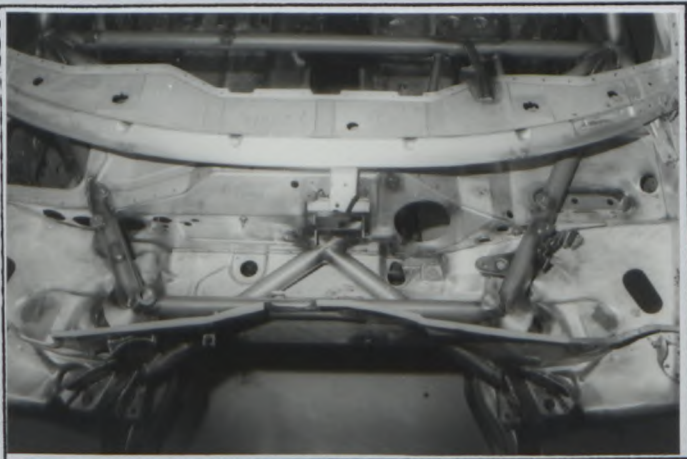
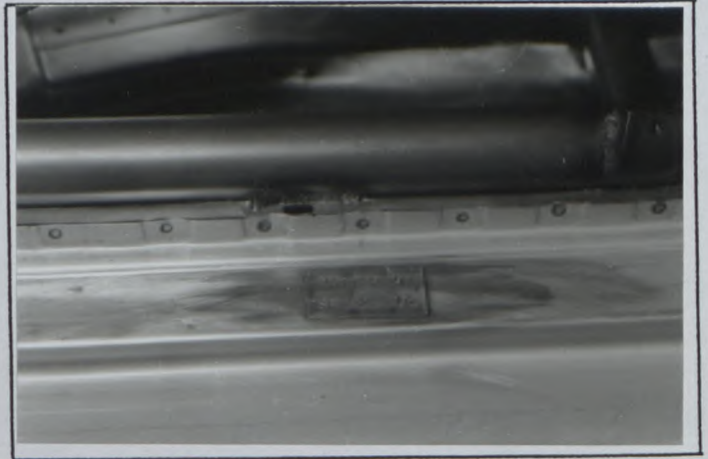

PHOTO No 12





FEDERATION INTERNATIONALE DE L'AUTOMOBILE

Homologation N°

ST-017

Extension N°

12/08VO

VO

FICHE D'EXTENSION D'HOMOLOGATION POUR DISPOSITIFS AERODYNAMIQUES EN SUPERTOURISME HOMOLOGATION EXTENSION FORM FOR AERODYNAMIC DEVICES IN SUPER TOURING

Homologation valable à partir du Homologation valid as from

01 MARS 1997

Véhicule : Constructeur Audi AG Vehicle: Manufacturer

Modèle et type Audi A4 Model and type

A) Voiture vue de 3/4 avant Car seen from 3/4 front

B) Voiture vue de 3/4 arrière Car seen from 3/4 rear



9. CARROSSERIE / BODYWORK

XVI) DISPOSITIF AVANT DEPOSE ET VU DE FACE AVEC DIMENSIONS DES OUVERTURES : DISMOUNTED FRONT DEVICE SEEN FROM FRONT WITH DIMENSIONS OF OPENINGS:

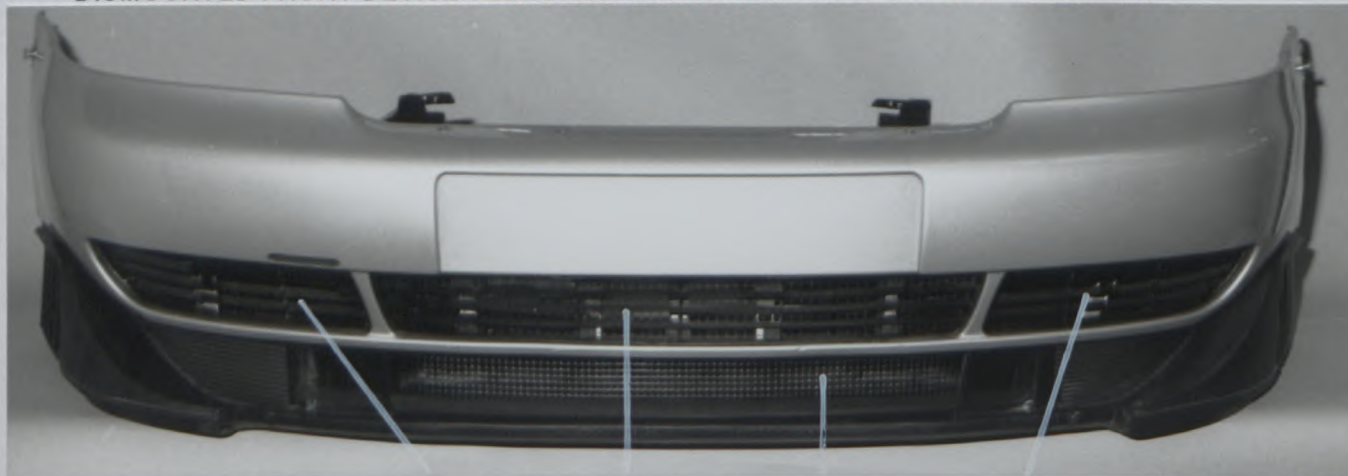

openings see drawing: A B C D

Marque
Make

Audi

Modèle
Model

Audi A4

Homologation N°

ST-017

Extension N°

12/08V0

XVIII) DISPOSITIF AVANT DEPOSE ET VU DE COTE AVEC DIMENSIONS DES OUVERTURES :
DISMOUNTED FRONT DEVICE IN SIDE VIEW WITH DIMENSIONS OF OPENINGS:



opening see drawing: E

XXIII) DISPOSITIF AVANT EN PLACE ET VU DE FACE :
MOUNTED FRONT DEVICE SEEN FROM FRONT:



XXIV) DISPOSITIF AVANT EN PLACE ET VU DE COTE :
MOUNTED FRONT DEVICE IN SIDE VIEW:



FÉDÉRATION INTERNATIONALE
DE L'AUTOMOBILE

3, place de la Concorde, 75008 Paris

Services Administratifs :

8 bis, rue Boissy d'Anglas, 75008 Paris

Marque
Make

Audi

Modèle
Model

Audi A4

Homologation N°

ST-017

Extension N°

12/08V0

XVII) DISPOSITIF ARRIERE EN PLACE
ET VU DE COTE :
MOUNTED REAR DEVICE IN SIDE VIEW:



XIX) SECTION DU DISPOSITIF ARRIERE AU
NIVEAU DE L'AXE LONGITUDINAL DE LA
VOITURE :
SECTION OF REAR DEVICE AT CAR'S
CENTERLINE LEVEL:

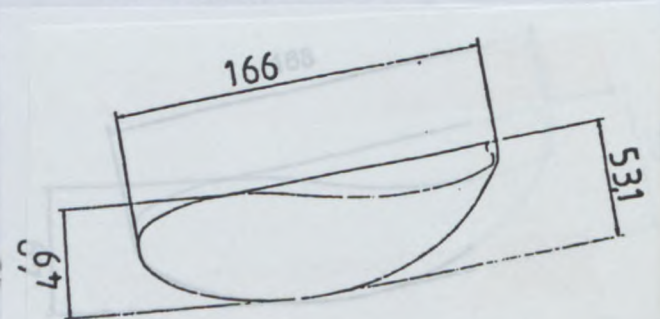

XX) DISPOSITIF ARRIERE EN PLACE ET VU DE DESSUS :
MOUNTED REAR DEVICE SEEN FROM ABOVE:



XXI) DISPOSITIF ARRIERE DEPOSE ET
VU DE COTE :
DISMOUNTED REAR DEVICE IN SIDE VIEW:



Marque
Make

Audi

Modèle
Model

Audi A4

Homologation N°

ST-017

Extension N°

12/08 VO

XXII) DISPOSITIF ARRIERE DEPOSE ET VU DE DESSUS :
DISMOUNTED REAR DEVICE SEEN FROM ABOVE:

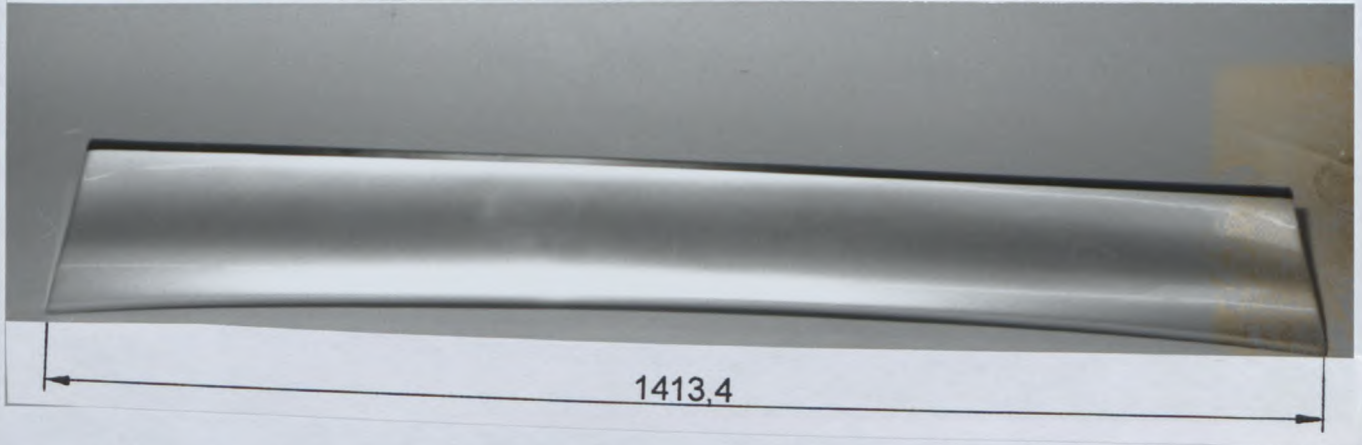

902. Extérieur : p) Angle entre dispositif arrière et carrosserie $12,5^\circ$
Exterior: Angle between rear device and bodywork $\pm 1^\circ$



INFORMATIONS COMPLEMENTAIRES / COMPLEMENTARY INFORMATION :

all dimensions in mm and $\pm 1\%$ tolerance

Photo XVIII: inside engine compartment mounted airducts on the plate for air exhaust

902 p) Angle between rear device and bodywork is measured in position shown on this drawing:

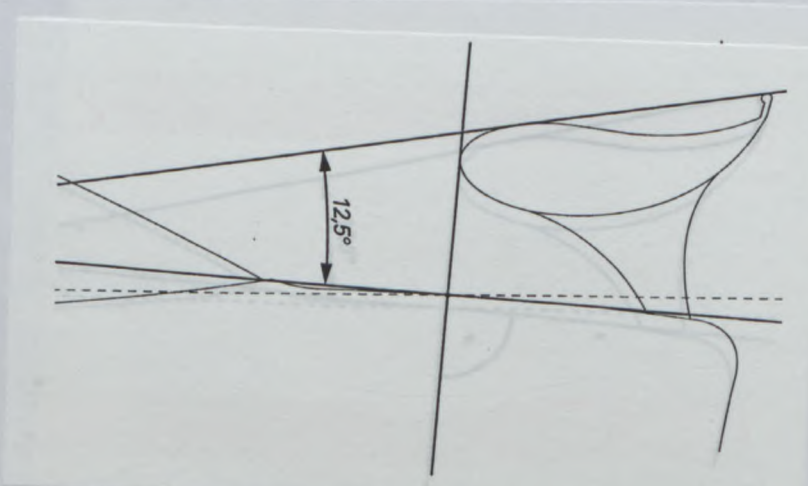

FEDERATION INTERNATIONALE
DE L'AUTOMOBILE

8, place de la Concorde, 75008 Paris

Services Administratifs :

8 bis, rue Boissy d'Anglas, 75008 Paris

Marque
Make

Audi

Modèle
Model

Audi A4

Homologation No

ST-017

Extension No

12/08V0

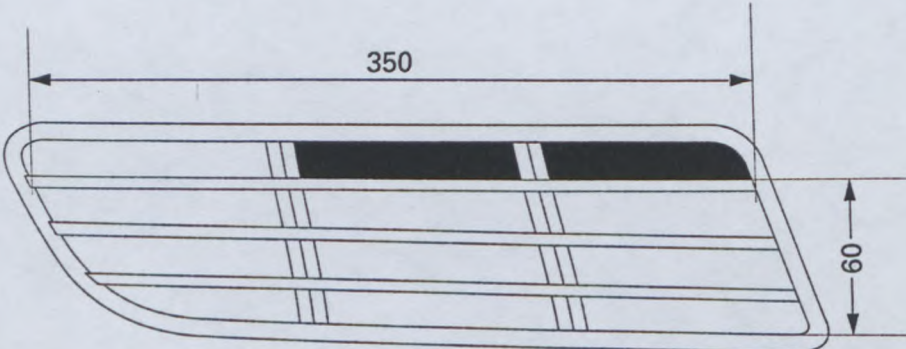
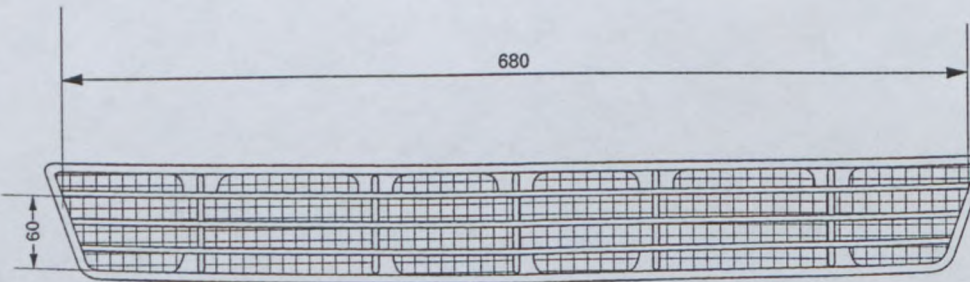
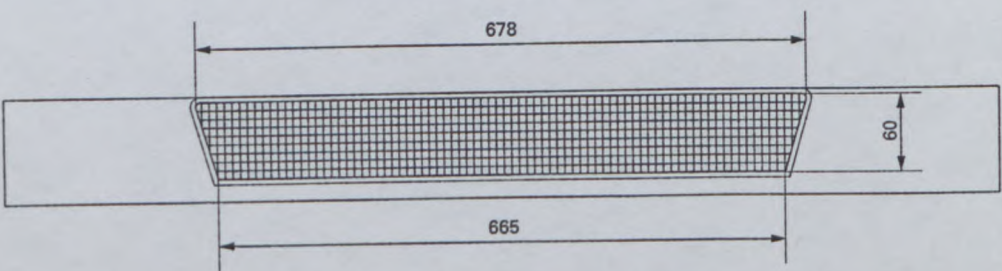
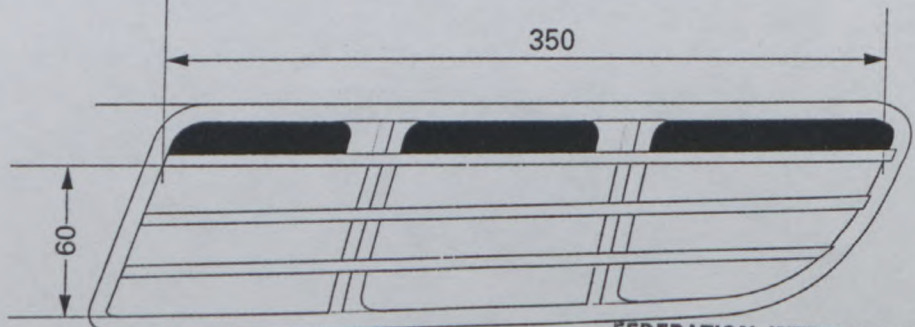
Page ou ext. Page or ext.	Article Article	Description Description
		<p data-bbox="375 425 526 459">drawing A</p>  <p data-bbox="375 851 526 884">drawing B</p>  <p data-bbox="375 1265 526 1299">drawing C</p>  <p data-bbox="375 1691 526 1724">drawing D</p> 

© FIA - FC - 1990 - 010.04.FB.11.94

Marque
Make

Audi

Modèle
Model

Audi A4

Homologation No

ST-017

Extension No

12/08V0

Page ou ext.
Page or ext.

Article
Article

Description
Description

drawing E

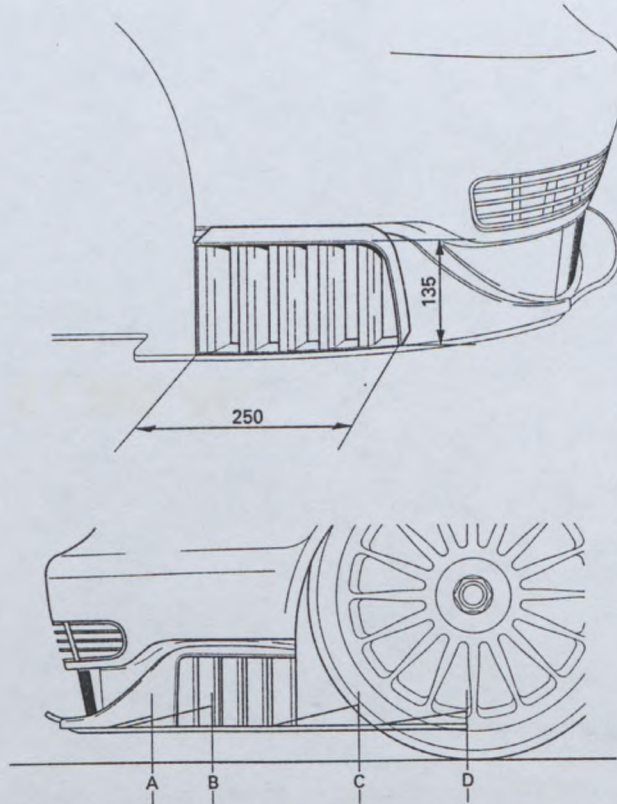

Schnitt A



Schnitt B

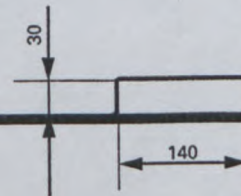

Schnitt C

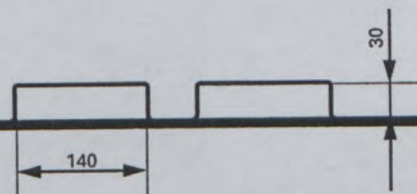

Schnitt D

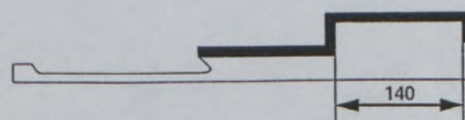

FEDERATION INTERNATIONALE
DE L'AUTOMOBILE

8, place de la Concorde, 75008 Paris

Services Administratifs :

8 bis, rue Boissy d'Anglas, 75008 Paris



FEDERATION INTERNATIONALE DE L'AUTOMOBILE

Homologation No

ST-017

Groupe / Group

~~A/B/N/T1~~

Supertourisme / Supertouring

Extension No

13/02 VF

FICHE D'EXTENSION D'HOMOLOGATION / FORM OF HOMOLOGATION EXTENSION

- ES Evolution sportive du type / Sporting evolution of the
ET Evolution normale du type / Normal evolution of the
XX VF Variante de fourniture / Supply variant
VO Variante option / Option variant
ER Erratum / Erratum

Vehicule: Constructeur / Vehicle: Manufactureur

Audi AG

Modele et type / Model and type

Audi A4

Homologation valable a partir du / Homologation valid as from

01 MARS 1997

Table with 3 columns: Page ou ext., Article, Description. Row 1: page 1, Photo B: Wahlweise Rücklicht mit unterschiedlicher Farbgebung bei gleicher Außensilhouette / optional rear lights with different colours and same exterior silhouette old: [Image of old rear light], new: [Image of new rear light]

© FIA - FC - 1990 - 010.04.FB.11.94

Fédération Internationale de l'Automobile
8, place de la Concorde, 75008 Paris
Services Administratifs:
8 bis rue Boissy d'Anglas, 75008 Paris



FEDERATION INTERNATIONALE DE L'AUTOMOBILE

Homologation N°

ST-017

Extension N°

14/09 VO

VO

FICHE D'EXTENSION D'HOMOLOGATION POUR DISPOSITIFS AERODYNAMIQUES EN SUPERTOURISME
HOMOLOGATION EXTENSION FORM FOR AERODYNAMIC DEVICES IN SUPER TOURING

Homologation valable à partir du 01 AVR. 1998
Homologation valid as from

Véhicule : Constructeur AUDI AG
Vehicle: Manufacturer

Modèle et type Audi A4
Model and type

A) Voiture vue de 3/4 avant
Car seen from 3/4 front



B) Voiture vue de 3/4 arrière
Car seen from 3/4 rear



9. CARROSSERIE / BODYWORK

XVI) DISPOSITIF AVANT DEPOSE ET VU DE FACE AVEC DIMENSIONS DES OUVERTURES :
DISMOUNTED FRONT DEVICE SEEN FROM FRONT WITH DIMENSIONS OF OPENINGS:

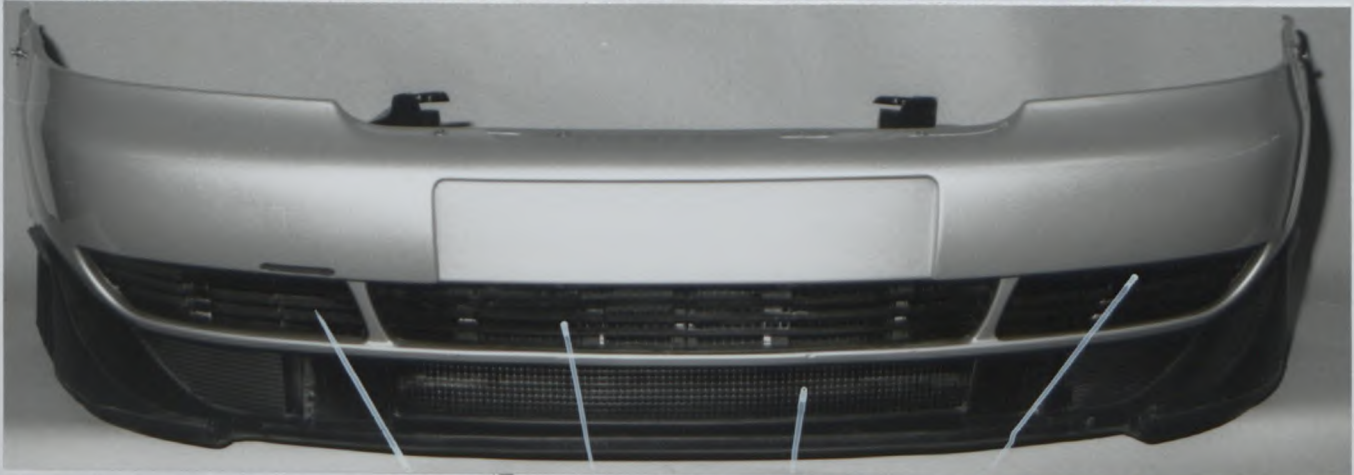

openings see drawing: A B C D

Marque
Make

Audi

Modèle
Model

Audi A4

Homologation N°

ST-017

Extension N°

14/09V0

XVIII) DISPOSITIF AVANT DEPOSE ET VU DE COTE AVEC DIMENSIONS DES OUVERTURES :
DISMOUNTED FRONT DEVICE IN SIDE VIEW WITH DIMENSIONS OF OPENINGS:



opening see drawing: E

XXIII) DISPOSITIF AVANT EN PLACE ET VU DE FACE :
MOUNTED FRONT DEVICE SEEN FROM FRONT:



XXIV) DISPOSITIF AVANT EN PLACE ET VU DE COTE :
MOUNTED FRONT DEVICE IN SIDE VIEW:



FEDERATION INTERNATIONALE
DE L'AUTOMOBILE

8, place de la Concorde, 75008 Paris

Services Administratifs :

8 bis, rue Boissy d'Anglas, 75008 Paris

Marque Audi
Make

Modèle Audi A4
Model

Homologation N°

ST-017

Extension N°

14/09V0

XVII) DISPOSITIF ARRIERE EN PLACE
ET VU DE COTE :
MOUNTED REAR DEVICE IN SIDE VIEW:



XIX) SECTION DU DISPOSITIF ARRIERE AU
NIVEAU DE L'AXE LONGITUDINAL DE LA
VOITURE :
SECTION OF REAR DEVICE AT CAR'S
CENTERLINE LEVEL:

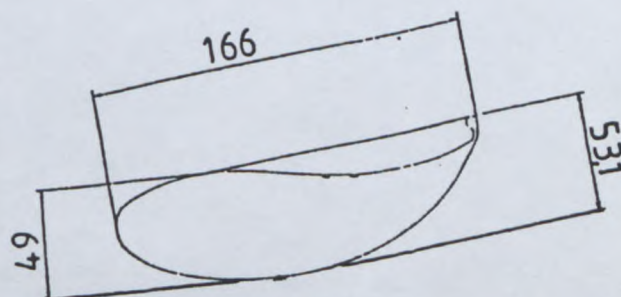

XX) DISPOSITIF ARRIERE EN PLACE ET VU DE DESSUS :
MOUNTED REAR DEVICE SEEN FROM ABOVE:



XXI) DISPOSITIF ARRIERE DEPOSE ET
VU DE COTE :
DISMOUNTED REAR DEVICE IN SIDE VIEW:



**FEDERATION INTERNATIONALE
DE L'AUTOMOBILE**

8, place de la Concorde, 75008 Paris

Services Administratifs :

8 bis, rue Boissy d'Anglas, 75008 Paris

Marque
Make

Audi

Modèle
Model

Audi A4

Homologation N°

ST-017

Extension N°

14/09V0

XXII) DISPOSITIF ARRIERE DEPOSE ET VU DE DESSUS :
DISMOUNTED REAR DEVICE SEEN FROM ABOVE:

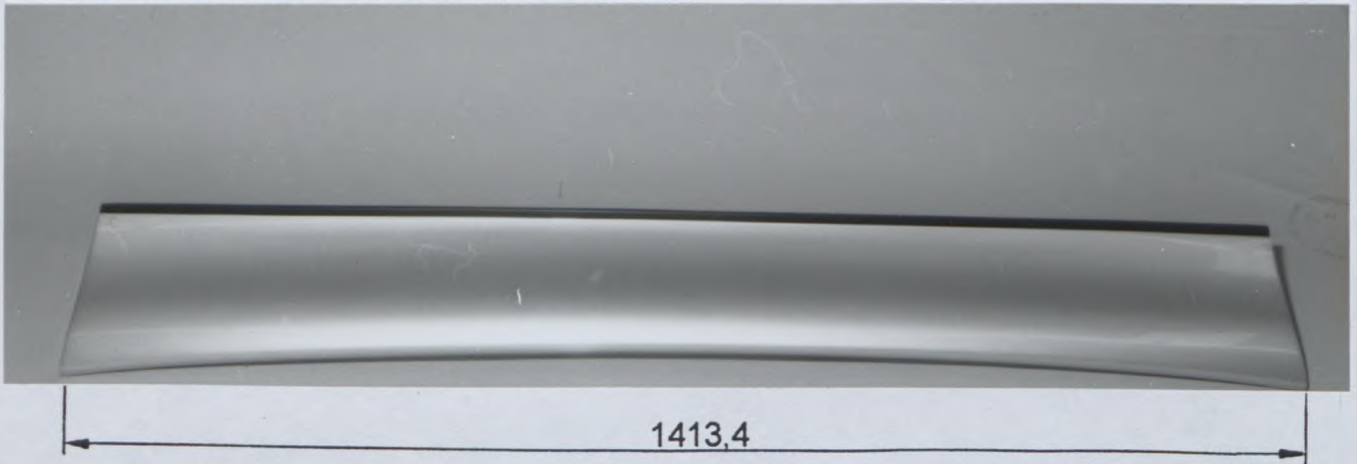

902. Extérieur : p) Angle entre dispositif arrière et carrosserie $12,5^\circ \pm 1^\circ$
Exterior: Angle between rear device and bodywork



INFORMATIONS COMPLEMENTAIRES / COMPLEMENTARY INFORMATION :

all dimensions in mm and $\pm 1\%$ tolerance

Photo XVIII: inside engine compartment mounted airducts on the plate for air exhaust

902 p) Angle between rear device and bodywork is measured in position shown on this drawing:

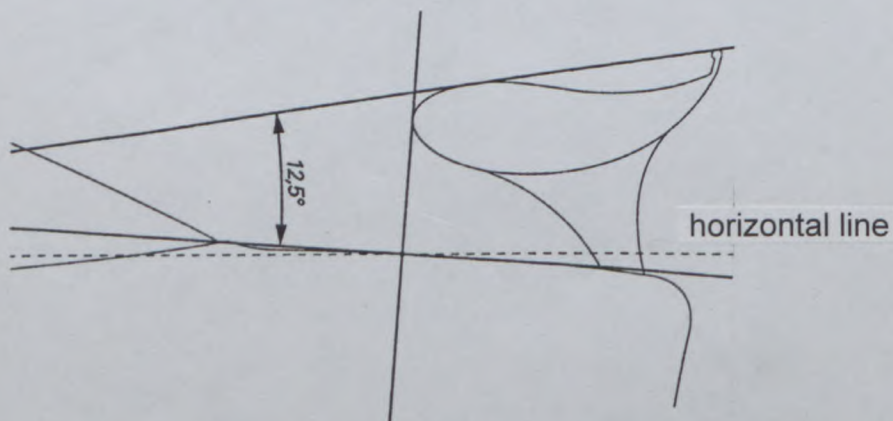

FEDERATION INTERNATIONALE
DE L'AUTOMOBILE

8, place de la Concorde, 75008 Paris

Services Administratifs :

8 bis, rue Boissy d'Anglas, 75008 Paris

Marque
Make

Audi

Modèle
Model

Audi A4

Homologation No

ST-017

Extension No

14/09V0

Page ou ext.
Page or ext.

Article
Article

Description
Description

drawing A

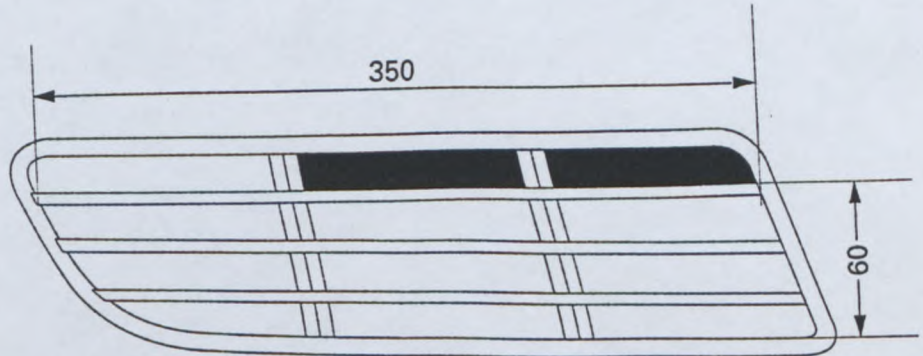

drawing B

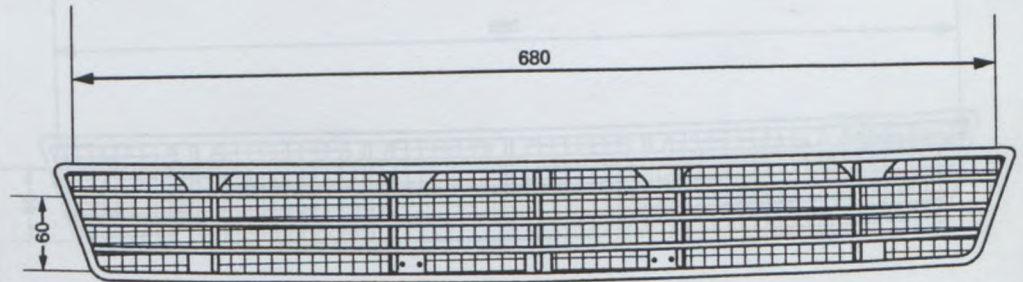

drawing C

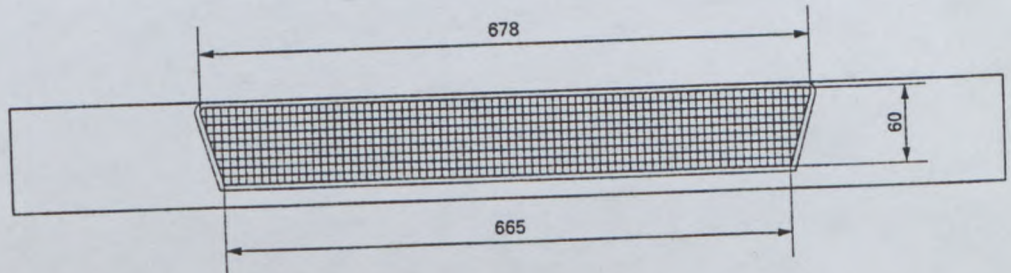

drawing D

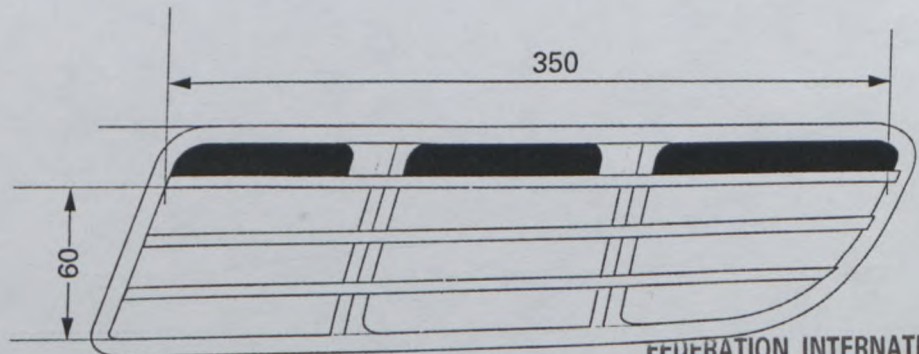

FEDERATION INTERNATIONALE
DE L'AUTOMOBILE

8, place de la Concorde, 75008 Paris

Services Administratifs :

8 bis, rue Boissy d'Anglas, 75008 Paris

Marque
Make Audi

Modèle
Model Audi A4

Homologation No
ST-017

Extension No
14/09V0

Page ou ext. Page or ext.	Article Article	Description Description
------------------------------	--------------------	----------------------------

drawing E

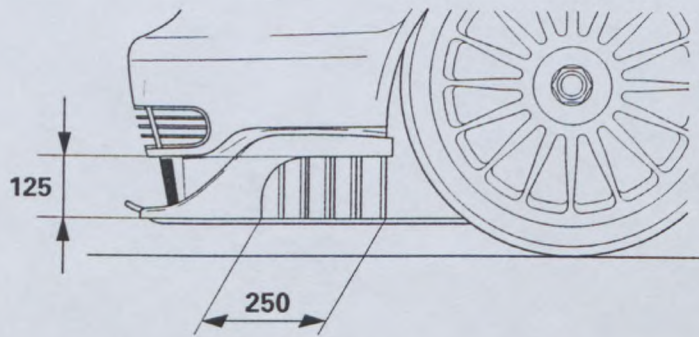

© FIA - FC - 1990 - 010.04.FB.11.94

**FEDERATION INTERNATIONALE
DE L'AUTOMOBILE**
8, place de la Concorde, 75008 Paris
Services Administratifs :
8 bis, rue Boissy d'Anglas, 75008 Paris



FEDERATION INTERNATIONALE DE L'AUTOMOBILE

Homologation N°

ST-017

Extension N°

15/10 VO

VO

FICHE D'EXTENSION D'HOMOLOGATION POUR DISPOSITIFS AERODYNAMIQUES EN SUPERTOURISME
HOMOLOGATION EXTENSION FORM FOR AERODYNAMIC DEVICES IN SUPER TOURING

Homologation valable à partir du 01 AVR. 1999
Homologation valid as from

Véhicule : Constructeur AUDI AG
Vehicle: Manufacturer

Modèle et type Audi A4
Model and type

A) Voiture vue de 3/4 avant
Car seen from 3/4 front



B) Voiture vue de 3/4 arrière
Car seen from 3/4 rear



9. CARROSSERIE / BODYWORK

XVI) DISPOSITIF AVANT DEPOSE ET VU DE FACE AVEC DIMENSIONS DES OUVERTURES :
DISMOUNTED FRONT DEVICE SEEN FROM FRONT WITH DIMENSIONS OF OPENINGS:



openings see drawing: A B C D

Marque
Make

Audi

Modèle
Model

Audi A4

Homologation N°

ST-017

Extension N°

15/10V0

XVIII) DISPOSITIF AVANT DEPOSE ET VU DE COTE AVEC DIMENSIONS DES OUVERTURES :
DISMOUNTED FRONT DEVICE IN SIDE VIEW WITH DIMENSIONS OF OPENINGS:



opening see drawing: E

XXIII) DISPOSITIF AVANT EN PLACE ET VU DE FACE :
MOUNTED FRONT DEVICE SEEN FROM FRONT:

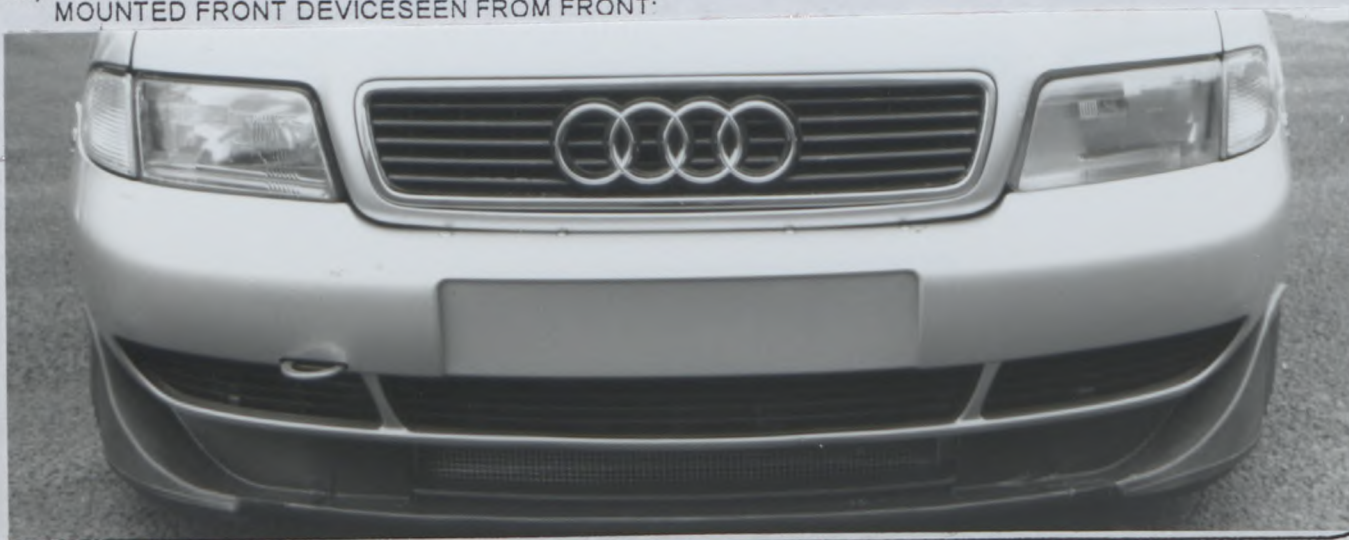

XXIV) DISPOSITIF AVANT EN PLACE ET VU DE COTE :
MOUNTED FRONT DEVICE IN SIDE VIEW:



Fédération Internationale de l'Automot
2 Chemin de Blandonnet
Case Postale 296
CH - 1215 GENEVE 15 Aéroport
SUISSE

Tél : 41 22 544 44 00
Fax Sport : 41 22 544 44 50
Fax Tourisme : 41 22 544 45 50

Marque
Make **AUDI**

Modèle
Model **AUDI A4**

Homologation N°

ST-017

Extension N°

15/10VO

XVII) DISPOSITIF ARRIERE EN PLACE ET VU DE COTE :
MOUNTED REAR DEVICE IN SIDE VIEW :

SEE ST-028 06/05 VO

XIX) SECTION DU DISPOSITIF ARRIERE AU NIVEAU
DE L'AXE LONGITUDINAL DE LA VOITURE :
SECTION OF REAR DEVICE AT CAR'S CENTER
LINE LEVEL :

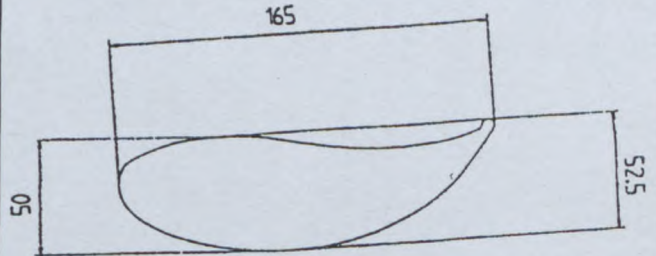

XX) DISPOSITIF ARRIERE EN PLACE ET VU DE DESSUS :
MOUNTED REAR DEVICE SEEN FROM ABOVE :

SEE ST-028 06/05 VO

XXI) DISPOSITIF ARRIERE DEPOSE ET VU DE COTE :
DISMOUNTED REAR DEVICE IN SIDE VIEW :

SEE ST-028 06/05 VO

**All measures on all pages
have a tolerance of +/- 1%**

Fédération Internationale de l'Automobile
2 Chemin de Blandonnet
Case Postale 296
CH - 1215 GENEVE 15 Aéroport
SUISSE

Tél : 41 22 544 44 00
Fax Sport : 41 22 544 44 50
Fax Tourisme : 41 22 544 45 50

Marque
Make **AUDI**

Modèle
Model **AUDI A4**

Homologation N°

ST-017

Extension N°

15/10 VO

XXII) DISPOSITIF ARRIERE DEPOSE ET VU DE DESSUS :
DISMOUNTED REAR DEVICE SEEN FROM ABOVE :

SEE ST-028 06/05 VO

LARGEUR DU DISPOSITIF / WIDTH OF THE DEVICE = 1413.4 mm

902. Extérieur : p) Angle entre dispositif arrière et carrosserie
Exterior : Angle between rear device and bodywork 10.5 +/- 1°



INFORMATIONS COMPLEMENTAIRES / COMPLEMENTARY INFORMATION :

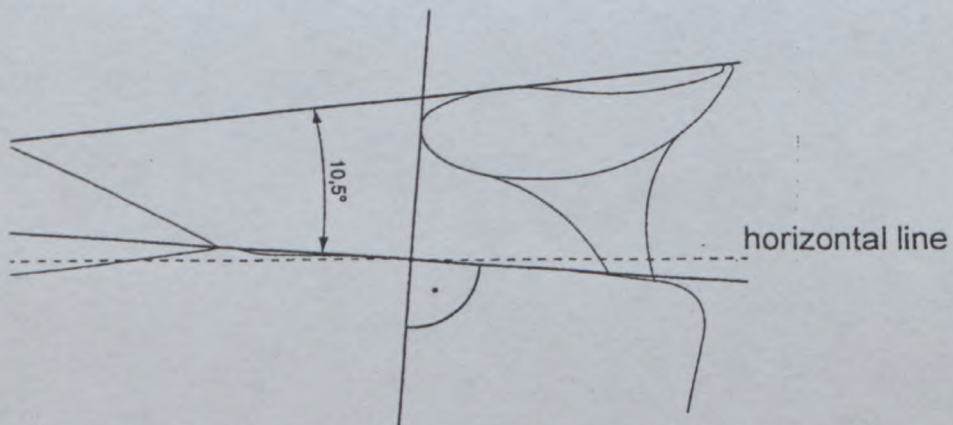

Fédération Internationale de l'Automobile
2 Chemin de Blandonnet
Case Postale 296
CH - 1215 GENEVE 15 Aéroport
SUISSE
Tél : 41 22 544 44 00
Fax Sport : 41 22 544 44 50
Fax Tourisme : 41 22 544 45 50

Marque Audi Modèle Audi A4
 Make _____ Model _____

ST-017

Extension N°

15 / 10 V0

903. Passage de roue "Aile" :
 Mudguard "Wing" :

Voir description ci-dessous
 See description below

	Avant / Front	Arrière / Rear
a) A	<u>248</u> mm +/- 1%	<u>360</u> mm +/- 1%
b) B	<u>238</u> mm +/- 1%	<u>340</u> mm +/- 1%
c) C	<u>270</u> mm +/- 1%	<u>374</u> mm +/- 1%
d) D	<u>687</u> mm +/- 1%	<u>652</u> mm +/- 1%

Fédération Internationale de l'Automobile
 2 Chemin de Blandonnet
 Case Postale 296
 CH - 1215 GENEVE 15 Aéroport
 SUISSE
 Tél : 41 22 544 44 00
 Fax Sport : 41 22 544 44 50
 Fax Tourisme : 41 22 544 45 50

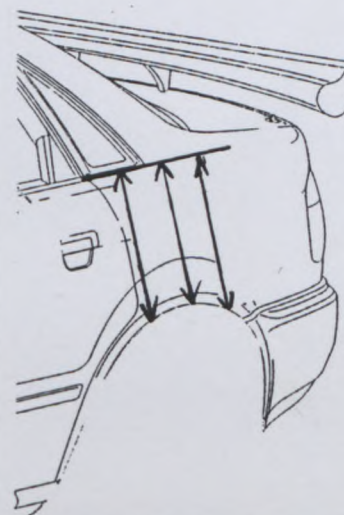
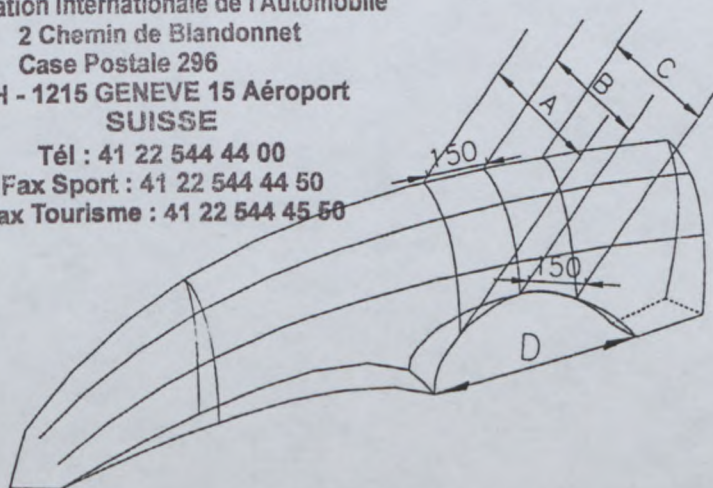

V) Aile avant modifiée
 Front wing modified



W) Aile arrière modifiée
 Rear wing modified



Page ou ext. Page or ext.	Article Article	Description Description
------------------------------	--------------------	----------------------------

drawing A

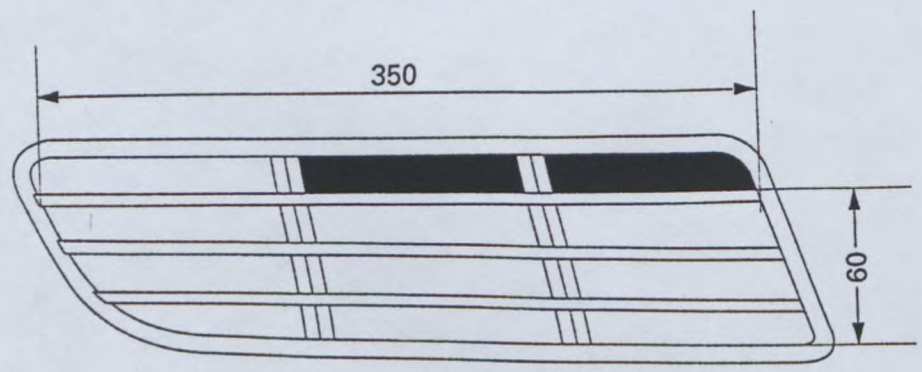

drawing B

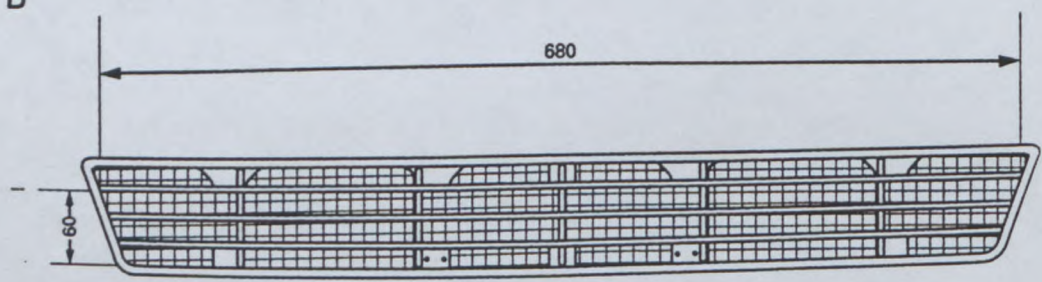

drawing C

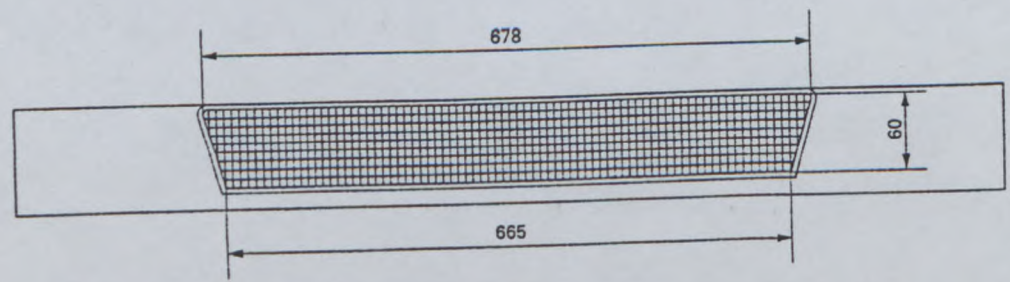

drawing D

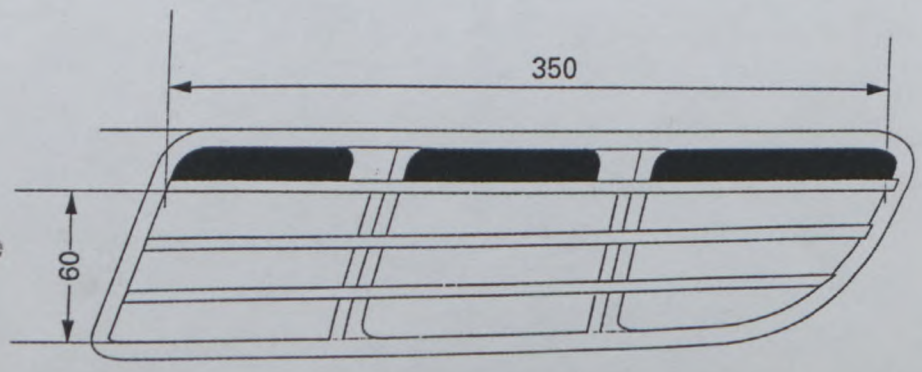

Q FIA - FC - 1990 - 010.04.FB.11.94

Fédération Internationale de l'Automobile
2 Chemin de Blandonnet
Case Postale 296
CH - 1215 GENEVE 15 Aéroport
SUISSE
Tél: 41 22 544 44 00
Fax Sport : 41 22 544 44 50
Fax Tourisme : 41 22 544 45 50

Marque Audi
Make Audi

Modèle Audi A4
Model Audi A4

Homologation No
ST-017

Extension No
15/10V0

Page ou ext. Page or ext.	Article Article	Description Description
------------------------------	--------------------	----------------------------

drawing E

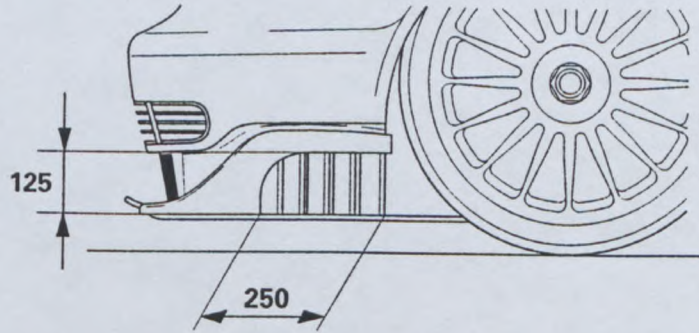

© FIA - FC - 1990 - 010.04.FB.1194

Fédération Internationale de l'Automobile
2 Chemin de Blandonnet
Case Postale 296
CH - 1215 GENEVE 15 Aéroport
SUISSE
Tél : 41 22 544 44 00
Fax Sport : 41 22 544 44 50
Fax Tourisme : 41 22 544 45 50